



## ROYAL CANADIAN SEA CADETS

BOOK 2 OF 2

# PHASE THREE INSTRUCTIONAL GUIDES

(ENGLISH)

(Supersedes A-CR-CCP-603/PF-001 dated 2015-12-01)

Cette publication est disponible en français sous le numéro A-CR-CCP-603/PF-002.

**Issued on Authority of the Chief of the Defence Staff**

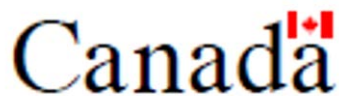



### NOTICE

This documentation has been reviewed by the technical authority and does not contain controlled goods. Disclosure notices and handling instructions originally received with the document shall continue to apply.

### AVIS

Cette documentation a été révisée par l'autorité technique et ne contient pas de marchandises contrôlées. Les avis de divulgation et les instructions de manutention reçues originalement doivent continuer de s'appliquer.



## ROYAL CANADIAN SEA CADETS

BOOK 2 OF 2

# PHASE THREE INSTRUCTIONAL GUIDES

(ENGLISH)

(Supersedes A-CR-CCP-603/PF-001 dated 2015-12-01)

Cette publication est disponible en français sous le numéro A-CR-CCP-603/PF-002.

**Issued on Authority of the Chief of the Defence Staff**

**LIST OF EFFECTIVE PAGES**

Insert latest changed pages; dispose of superseded pages in accordance with applicable orders.

**NOTE**

On a changed page, the portion of the text affected by the latest change is indicated by a vertical line in the margin of the page. Changes to illustrations by miniature pointing hands, or black vertical lines.

Dates of issue for original and changed pages are:

Original .....	0 .....	2016-08-24	Change .....	3 .....
Change .....	1 .....		Change .....	4 .....
Change .....	2 .....		Change .....	5 .....

Zero in Change No. column indicates an original page. Total number of pages in this publication is 267, consisting of the following:

<b>Page No.</b>	<b>Change No.</b>	<b>Page No.</b>	<b>Change No.</b>
<b>BOOK 2</b>		13-322-1 to 13-322-2 .....	0
Cover page .....	0	14-323-1/2 .....	0
Title .....	0	14-M323.01-1 to 14-M323.01-8.....	0
A .....	0	14-C323.01-1 to 14-C323.01-16.....	0
i to viii .....	0	14-C323.02-1 to 14-C323.02-4.....	0
11-X20-1/2 .....	0	14-C323.03-1 to 14-C323.03-6.....	0
11-X20-1 to 11-X20-2 .....	0	14A-1 to 14A-2 .....	0
12-321-1/2 .....	0	14B-1 to 14B-2 .....	0
12-M321.01-1 to 12-M321.01-8.....	0	14C-1 to 14C-2 .....	0
12-M321.02-1 to 12-M321.02-20.....	0	14D-1 to 14D-2 .....	0
12-C321.02-1 to 12-C321.02-14.....	0	14E-1 to 14E-2 .....	0
12-C321.03-1 to 12-C321.03-16.....	0	14F-1 to 14F-2 .....	0
12-C321.04-1 to 12-C321.04-6.....	0	14G-1 to 14G-2 .....	0
12-C321.05-1 to 12-C321.05-6.....	0	14H-1 to 14H-2 .....	0
12A-1 to 12A-2 .....	0	14I-1 to 14I-6 .....	0
12B-1 to 12B-2 .....	0	14J-1 to 14J-2 .....	0
12C-1 to 12C-2 .....	0	14K-1 to 14K-2 .....	0
12D-1 to 12D-2 .....	0	14L-1 to 14L-2 .....	0
12E-1 to 12E-2 .....	0	14M-1 to 14M-2 .....	0
12F-1 to 12F-2 .....	0	15-X24-1/2 .....	0
12G-1 to 12G-2 .....	0	15-X24-1 to 15-X24-2 .....	0
12H-1 to 12H-2 .....	0	16-X25-1/2 .....	0
12I-1 to 12I-2 .....	0	16-X25-1 to 16-X25-2 .....	0
12J-1 to 12J-2 .....	0	17-1/2 .....	0
12K-1 to 12K-2 .....	0	17-1 to 17-20 .....	0
12L-1 to 12L-2 .....	0	17A-1 to 17A-10 .....	0
12M-1 to 12M-8 .....	0	17B-1 to 17B-6 .....	0
12N-1 to 12N-2 .....	0	17C-1 to 17C-2 .....	0
12O-1 to 12O-12 .....	0	17D-1 to 17D-4 .....	0
12P-1 to 12P-2 .....	0	17E-1 to 17E-6 .....	0
13-322-1/2 .....	0	17F-1 to 17F-2 .....	0
		17G-1 to 17G-2 .....	0



## FOREWORD AND PREFACE

1. **Issuing Authority.** This Instructional Guide (IG) A-CR-CCP-603/PF-001 was developed under the authority of the Director Cadets and Junior Canadian Rangers, and issued on the authority of the Chief of Defence Staff.
2. **Development.** Development of this IG was in accordance with the performance oriented concept of training outlined in the A-P9-050 Series, Canadian Forces Individual Training and Education System, with modifications to meet the needs of the Cadet Organization.
3. **Purpose of the IG.** The IG to be used by Royal Canadian Sea Cadet Corps in conjunction with other resources to conduct Phase Three training. The IG provides instructors with the base means from which to deliver training. Individual IGs are to be reviewed in conjunction with the Lesson Specifications (LSs) found in A-CR-CCP-603/PG-001, *Royal Canadian Sea Cadets Phase Three Qualification Standard and Plan*, Chapter 4, before instructing, so that each instructor can adequately plan for and prepare each lesson. Instructors may be required to develop instructional materials to support training in addition to any that may be provided, e.g., posters, videos, handouts, models, etc, supplemental to training control and support documents. Suggested instructional activities are included in most IGs to maximize learning and fun. Instructors are also encouraged to modify and/or enhance the activities, as long as they continue to contribute to enabling objective achievement.
4. **Use of the IG.** Throughout these instructional guides, a series of information boxes are used to highlight information; they include:



Note to the Instructor.



Key information to pass along to cadets.



Refer to the following CF regulations and policies.



Points of interest or special instructions the instructor should pass along to cadets.

5. **Suggested Changes.** Suggested changes to this document may be sent directly to [cadettraining@canada.ca](mailto:cadettraining@canada.ca).

THIS PAGE INTENTIONALLY LEFT BLANK

## TABLE OF CONTENTS

PAGE

## BOOK 2

<b>CHAPTER 11</b>	<b>PO X20 – PARTICIPATE IN CANADIAN ARMED FORCES (CAF) FAMILIARIZATION ACTIVITIES</b>	11-X20-1/2
<b>CHAPTER 12</b>	<b>PO 321 – RIG A LIFTING DEVICE</b>	12-321-1/2
Section 1	EO M321.01 – DESCRIBE SAFETY PROCEDURES FOR OPERATING LIFTING DEVICES.....	12-M321.01-1
Section 2	EO M321.02 – RIG SHEERS.....	12-M321.02-1
Section 3	EO C321.02 – RIG A STANDING DERRICK.....	12-C321.02-1
Section 4	EO C321.03 – RIG A GYN.....	12-C321.03-1
Section 5	EO C321.04 – MAKE A MONKEY’S FIST.....	12-C321.04-1
Section 6	EO C321.05 – MAKE A TURK’S HEAD.....	12-C321.05-1
Annex A	PARTS CARDS – SHEERS.....	12A-1
Annex B	ASSEMBLED SHEERS.....	12B-1
Annex C	SEQUENCE FOR STATION 3 – OPERATING THE SHEERS.....	12C-1
Annex D	SHEERS SCORESHEET.....	12D-1
Annex E	PARTS CARDS – STANDING DERRICK.....	12E-1
Annex F	STANDING DERRICK.....	12F-1
Annex G	SEQUENCE FOR STATION 3 – OPERATING A STANDING DERRICK.....	12G-1
Annex H	STANDING DERRICK SCORESHEET.....	12H-1
Annex I	PARTS CARDS – GYN.....	12I-1
Annex J	ASSEMBLED GYN.....	12J-1
Annex K	SEQUENCE FOR STATION 3 – OPERATING A GYN.....	12K-1
Annex L	GYN SCORESHEET.....	12L-1
Annex M	ALTERNATIVE METHOD FOR MAKING A MONKEY’S FIST.....	12M-1
Annex N	MONKEY’S FIST PATTERN.....	12N-1
Annex O	ALTERNATIVE METHOD FOR MAKING A TURK’S HEAD.....	12O-1
Annex P	TURKS HEAD PATTERN.....	12P-1
<b>CHAPTER 13</b>	<b>PO 322 – ATTAIN PLEASURE CRAFT OPERATOR COMPETENCY</b>	13-322-1/2
<b>CHAPTER 14</b>	<b>PO 323 – SERVE IN A NAVAL ENVIRONMENT</b>	14-323-1/2
Section 1	EO M323.01 – PERFORM CORPS DUTIES.....	14-M323.01-1
Section 2	EO C323.01 – COMMUNICATE USING FLAGS AND PENNANTS.....	14-C323.01-1
Section 3	EO C323.02 – PIPE WAKEY WAKEY.....	14-C323.02-1
Section 4	EO C323.03 – PIPE HANDS TO DINNER.....	14-C323.03-1
Annex A	FUNCTIONAL ORGANIZATION.....	14A-1
Annex B	DUTY PERSONNEL ORGANIZATION.....	14B-1

## TABLE OF CONTENTS (Cont)

		<b>PAGE</b>
Annex C	TRAINING ORGANIZATIONS.....	14C-1
Annex D	QUATERMASTER TERMS OF REFERENCE.....	14D-1
Annex E	QUATERMASTER REFERENCE GUIDE.....	14E-1
Annex F	FLAG FLASH CARDS.....	14F-1
Annex G	FLAG FLASH CARDS RESULTS SHEET.....	14G-1
Annex H	SIGNAL MAST HANDOUT.....	14H-1
Annex I	SIGNAL HOIST CUE CARDS.....	14I-1
Annex J	SIGNAL HOIST RESULTS SHEET.....	14J-1
Annex K	SIGNAL HOIST ANSWER KEY.....	14K-1
Annex L	WAKEY WAKEY DIAGRAM.....	14L-1
Annex M	HANDS TO DINNER DIAGRAM.....	14M-1
<b>CHAPTER 15</b>	<b>PO X24 – SAIL A SAILBOAT IN ACCORDANCE WITH SAIL CANADA CANSAIL LEVEL 1</b>	15-X24-1/2
<b>CHAPTER 16</b>	<b>PO X25 – PARTICIPATE IN A NAUTICAL TRAINING WEEKEND</b>	16-X25-1/2
<b>CHAPTER 17</b>	<b>SIDC</b>	17-1/2
	SEAMANSHIP INTERDIVISIONAL COMPETITION.....	17-1
Annex A	SCORESHEETS.....	17A-1
Annex B	SUGGESTED TRIVIA QUESTIONS.....	17B-1
Annex C	BOATSWAIN'S CALL CARDS.....	17C-1
Annex D	TASK CARDS.....	17D-1
Annex E	TYPES OF SHIPS.....	17E-1
Annex F	MOST LIKE ME ACTIVITY SHEET.....	17F-1
Annex G	SECRET MESSAGE CARDS.....	17G-1

## LIST OF FIGURES

FIGURE	TITLE	PAGE
<b>BOOK 2</b>		
12-1-1	Sheers Danger Zones.....	12-M321.01-4
12-1-2	Gyn Danger Zone.....	12-M321.01-5
12-1-3	Standing Derrick Danger Zone.....	12-M321.01-5
12-2-1	Assembled Sheers.....	12-M321.02-2
12-2-2	Assembled Sheers.....	12-M321.02-4
12-2-3	Sheers Head Lashing.....	12-M321.02-5
12-2-4	Strop on a Spar.....	12-M321.02-5
12-2-5	Timber Hitch Step 1.....	12-M321.02-7
12-2-6	Timber Hitch Step 2.....	12-M321.02-8
12-2-7	Timber Hitch Step 3.....	12-M321.02-8
12-2-8	Timber Hitch Step 4.....	12-M321.02-9
12-2-9	Completed Timber Hitch.....	12-M321.02-9
12-2-10	Choking a Luff.....	12-M321.02-10
12-2-11	Topping Lift and Main Purchase Strops.....	12-M321.02-12
12-2-12	Two-Fold Purchase.....	12-M321.02-13
12-2-13	Luff.....	12-M321.02-14
12-2-14	Heel Tackles Rigged to Advantage.....	12-M321.02-14
12-2-15	Mousing a Hook.....	12-M321.02-15
12-2-16	Sheers Run.....	12-M321.02-17
12-3-1	Standing Derrick.....	12-C321.02-3
12-3-2	Parts of a Standing Derrick.....	12-C321.02-4
12-3-3	Snotter.....	12-C321.02-5
12-3-4	Strop on a Spar.....	12-C321.02-5
12-3-5	Thumb Piece and Rope Collar.....	12-C321.02-6
12-3-6	Two-Fold Purchase.....	12-C321.02-8
12-3-7	Luff.....	12-C321.02-9
12-3-8	Mousing a Hook .....	12-C321.02-9
12-3-9	Standing Derrick Run.....	12-C321.02-11
12-4-1	Assembled Gyn.....	12-C321.03-2
12-4-2	Head Lashing.....	12-C321.03-3
12-4-3	Spars.....	12-C321.03-4
12-4-4	Main Purchase and Shoes.....	12-C321.03-4
12-4-5	Strop on a Spar.....	12-C321.03-5
12-4-6	Splay Tackles and Shoes.....	12-C321.03-5
12-4-7	Thumb piece and Rope Collar.....	12-C321.03-6
12-4-8	Head Lashing.....	12-C321.03-8
12-4-9	Head Lashing Strop.....	12-C321.03-9

## LIST OF FIGURES (Cont)

FIGURE	TITLE	PAGE
12-4-10	Two-Fold Purchase.....	12-C321.03-9
12-4-11	Gyn Splay Tackles.....	12-C321.03-10
12-4-12	Luff .....	12-C321.03-10
12-4-13	Mousing a Hook.....	12-C321.03-11
12-4-14	Assembled Gyn.....	12-C321.03-12
12-4-15	Gyn Run.....	12-C321.03-14
12-5-1	Monkey's Fist Step 1.....	12-C321.04-3
12-5-2	Monkey's Fist Step 2.....	12-C321.04-3
12-5-3	Monkey's Fist Step 3.....	12-C321.04-4
12-5-4	Completed Monkey's Fist.....	12-C321.04-4
12-6-1	Standing Turk's Head.....	12-C321.05-2
12-6-2	Running Turk's Head.....	12-C321.05-2
12-6-3	Steps 1–3.....	12-C321.05-3
12-6-4	Step 4.....	12-C321.05-3
12-6-5	Step 5.....	12-C321.05-4
12-6-6	Step 6.....	12-C321.05-4
12B-1	Assembled Sheers.....	12B-1
12F-1	Standing Derrick.....	12F-1
12J-1	Assembled Gyn.....	12J-1
12M-1	Typical Knot Pattern.....	12M-2
12M-2	Pattern Grid.....	12M-2
12M-3	Pattern Scaling Chart.....	12M-3
12M-4	Step 2.....	12M-4
12M-5	Step 3.....	12M-4
12M-6	Steps 4 and 5.....	12M-5
12M-7	Step 7.....	12M-6
12M-8	Step 8.....	12M-6
12M-9	Step 9.....	12M-7
12M-10	Step 10.....	12M-7
12M-11	Step 12.....	12M-8
12N-1	Monkey's Fist Pattern.....	12N-1
12O-1	Typical Knot Pattern–Cylinder Method.....	12O-2
12O-2	Pattern Grid.....	12O-2
12O-3	Pattern Scaling Chart.....	12O-3
12O-4	Step 2.....	12O-4
12O-5	Step 3.....	12O-4
12O-6	Step 4.....	12O-5
12O-7	Step 5.....	12O-6

## LIST OF FIGURES (Cont)

FIGURE	TITLE	PAGE
12O-8	Step 6.....	12O-6
12O-9	Step 7.....	12O-7
12O-10	Step 8.....	12O-7
12O-11	Step 10.....	12O-8
12O-12	Moving a Turn Pin.....	12O-9
12O-13	Step 11.....	12O-10
12O-14	Step 12.....	12O-10
12O-15	Step 13.....	12O-11
12O-16	Finished Turk's Head Bracelet.....	12O-11
12P-1	Turk's Head Pattern.....	12P-1
14-2-1	Common Flags and Pennants.....	14-C323.01-5
14-2-2	Layout for Flag Flash Card Activity.....	14-C323.01-8
14-2-3	Parts of a Signal Mast and Superior Positions.....	14-C323.01-10
14-2-4	Layout for Flag Hoist Activity.....	14-C323.01-13
14-3-1	Wakey Wakey.....	14-C323.02-3
14-4-1	Hands to Dinner.....	14-C323.03-4
14A-1	Functional Organization.....	14A-1
14B-1	Duty Personnel Organization.....	14B-1
14C-1	Training Organization – Option One.....	14C-1
14C-2	Training Organization – Option Two.....	14C-2
14E-1	The General Call.....	14E-2
14E-2	The Still.....	14E-2
14E-3	The Carry On.....	14E-2
14H-1	Parts of a Signal Mast and Superior Positions.....	14H-1
14L-1	Wakey Wakey.....	14L-1
14M-1	Hands to Dinner.....	14M-1
17-1	Coil and Heave a Line Activity Layout.....	17-3
17-2	Boatswain's Call Activity Layout.....	17-4
17-3	Knots, Bends and Hitches Activity Layout.....	17-5
17-4	Whipping and Splicing Activity Layout.....	17-7
17-5	Option One Trivia Activity Layout.....	17-9
17-6	Option Two Trivia Activity Layout.....	17-9
17-7	Across the River Activity Layout.....	17-14
17-8	Final Event Layout.....	17-17
17E-1	HMCS Algonquin.....	17E-1
17E-2	HMCS Brandon.....	17E-1
17E-3	HMCS Regina.....	17E-2
17E-4	HMCS Protecteur.....	17E-2

**LIST OF FIGURES (Cont)**

<b>FIGURE</b>	<b>TITLE</b>	<b>PAGE</b>
17E-5	Cargo Vessel.....	17E-3
17E-6	Cruise Ship.....	17E-3
17E-7	Car Ferry.....	17E-4
17E-8	Tanker.....	17E-4
17E-9	Tug Handling Supply Vessel.....	17E-5



**CHAPTER 11**

**PO X20 – PARTICIPATE IN CANADIAN ARMED FORCES (CAF) FAMILIARIZATION ACTIVITIES**





**COMMON TRAINING**  
**ALL TRAINING LEVELS**  
**INSTRUCTIONAL GUIDE**  
**CANADIAN ARMED FORCES**  
**(CAF) FAMILIARIZATION**



**PO X20 – PARTICIPATE IN CAF FAMILIARIZATION**

---

Total Time:

---

For the following EOs, refer to the lesson specifications located in A-CR-CCP-601/PG-001, *Royal Canadian Sea Cadets Phase One Qualification Standard and Plan*:

- MX20.01A – Participate in a CAF Activity,
- MX20.01B – Participate in a CAF Familiarization Tour,
- MX20.01E – Attend a CAF Presentation,
- MX20.01F – Attend a CAF Commemorative Ceremony, and
- CX20.01 – Participate in CAF Familiarization Activities.

For the following EOs, refer to the instructional guides located in A-CR-CCP-601/PF-001, *Royal Canadian Sea Cadets Phase One Instructional Guides*:

- MX20.01C – Fire the C7 Rifle,
- MX20.01D – Participate in a Mess Dinner,
- MX20.01G – Participate in CAF Familiarization Video Activities, and
- MX20.01H – Participate in CAF Familiarization Learning Stations.

THIS PAGE INTENTIONALLY LEFT BLANK

**CHAPTER 12**  
**PO 321 – RIG A LIFTING DEVICE**





## ROYAL CANADIAN SEA CADETS

### PHASE THREE

### INSTRUCTIONAL GUIDE



### SECTION 1

#### EO M321.01 – DESCRIBE SAFETY PROCEDURES FOR OPERATING LIFTING DEVICES

---

Total Time: 30 min

---

#### PREPARATION

---

##### PRE-LESSON INSTRUCTIONS

Resources needed for the delivery of this lesson are listed in the lesson specification located in A-CR-CCP-603/PG-001, Chapter 4. Specific uses for said resources are identified throughout the instructional guide within the TP for which they are required.

Review the lesson content and become familiar with the material prior to delivering the lesson.

##### PRE-LESSON ASSIGNMENT

N/A.

##### APPROACH

An interactive lecture was chosen for this lesson to introduce safety procedures for operating lifting devices.

---

#### INTRODUCTION

---

##### REVIEW

N/A.

##### OBJECTIVES

By the end of this lesson the cadet shall have described safety procedures for operating lifting devices.

##### IMPORTANCE

It is important for cadets to be familiar with personal safety equipment, safe practices and danger zones while working with lifting devices as there is the potential for injury if safety procedures are not followed.

---

**Teaching Point 1**

**Discuss Safety Procedures and Equipment for Operating Lifting Devices**

Time: 15 min

Method: Interactive Lecture

---

**SAFE PRACTICES**



It is essential that the following safe practices be applied at all times to avoid injury while working with lifting devices.

**Personal Conduct**

- Do not run or participate in horseplay.
- Do not stand in danger zones.
- Do not straddle or wrap lines around any part of the body.
- Do not stand in bights or coils of lines.
- Do not walk on spars.
- Do not throw equipment.

**Clothing**

- Avoid loose clothing while working with tackles.
- Avoid clothing with draw-strings or hanging zippers.

**Use of Rigging Equipment**

- Do not step over a tackle while it is under tension.
- Do not put hands through a tackle when choking a block.
- Do not put hands/fingers on a block under tension.
- Do not walk with an open knife.
- Do not cut towards the body.

**PERSONAL SAFETY EQUIPMENT**

The following personal safety equipment must be worn at all times while working with lifting devices:

- Hard hat,
- Issued cadet boots or safety boots, and
- Knife lanyard (if knife is used).

---

**CONFIRMATION OF TEACHING POINT 1**

---

**QUESTIONS**

- Q1. When shall safe practices be applied?
- Q2. What types of clothing should be avoided when operating lifting devices?



Q3. What personal safety equipment must be worn at all times while working with lifting devices?

### ANTICIPATED ANSWERS

A1. At all times.

A2. Loose clothing and clothing with draw-strings or hanging zippers.

A3. Personal safety equipment includes:

- Hard hat,
- Issued cadet boots or safety boots, and
- Knife lanyard (if knife is used).

---

### Teaching Point 2

### Describe Danger Zones

Time: 10 min

Method: Interactive Lecture

---

### DANGER ZONES

While operating lifting devices, there is the risk of injury due to a failure in the rigging equipment. To minimize this risk, danger zones have been determined that come into effect at specific times during the rigging.

#### Sheers

There are two main danger zones when rigging sheers that must be observed:

1. **Forward Danger Zone.** When the topping lift is heaved in, an area within an arc approximately 1 and 1/2 spar lengths in front of the sheers and extending out from the heels becomes a danger zone (as illustrated in Figure 12-1-1). If the heel tackles or topping lift fails, the sheers may fall forward within this area.
2. **Aft Danger Zone.** When the topping lift is heaved in, the area approximately 1 and 1/2 spar lengths directly behind the sheers and extending out from the after heel anchors becomes a danger zone (as illustrated in Figure 12-1-1). If the sheers are raised too high or the load becomes unhooked, the sheers may snap back and fall backward into this area. This risk can be minimized by fitting a martingale to the sheers.



When the splay tackles and heel tackles have been tensioned and choked, the area inside the spars becomes unsafe. If the tackles were to release accidentally, the spars may snap back quickly along the ground.

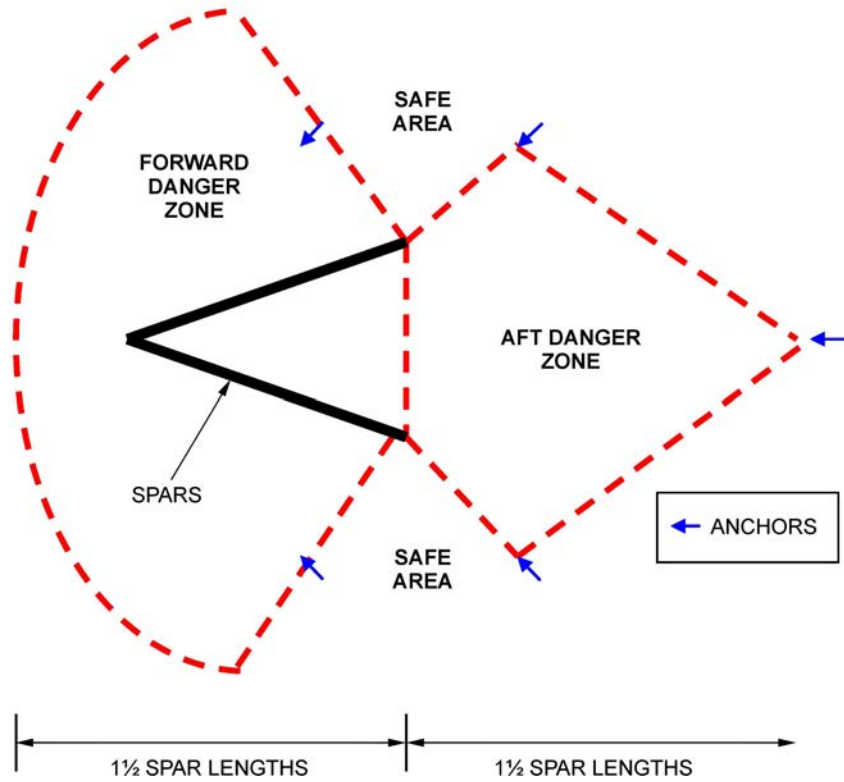

*Navy League of Canada, NLP 101 Flotilla and Provincial Seamanship Competition Manual, Navy League of Canada (p. 4)*

Figure 12-1-1 Sheers Danger Zones

## Gyn

When the splay tackles are heaved in to raise the gyn, the area between the heels becomes a danger zone. Care should be taken when working with the splay tackles and the main purchase.

Heave in the splay tackles in small increments when the gyn nears its full height as it can be heaved off balance easily and fall to the side. Cadets who are working with the splay tackles should stand close to the heels until the gyn reaches full height (as illustrated in Figure 12-1-2).

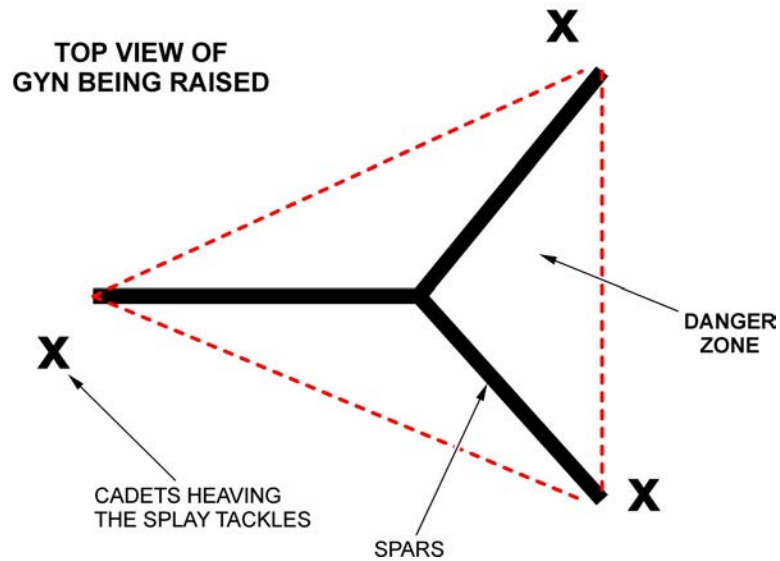

*Director Cadets 3, 2008, Ottawa, ON: Department of National Defence*

Figure 12-1-2 Gyn Danger Zone

### Standing Derrick

When the topping lift is heaved in to raise the standing derrick, the area within an arc approximately 1 and 1/2 spar lengths directly in front of the spar between the guy anchors becomes a danger zone. If the topping lift or one of the guys fails, the spar will fall within this area (as illustrated in Figure 12-1-3). The topping lift should be checked away before the load is hooked on or unhooked.

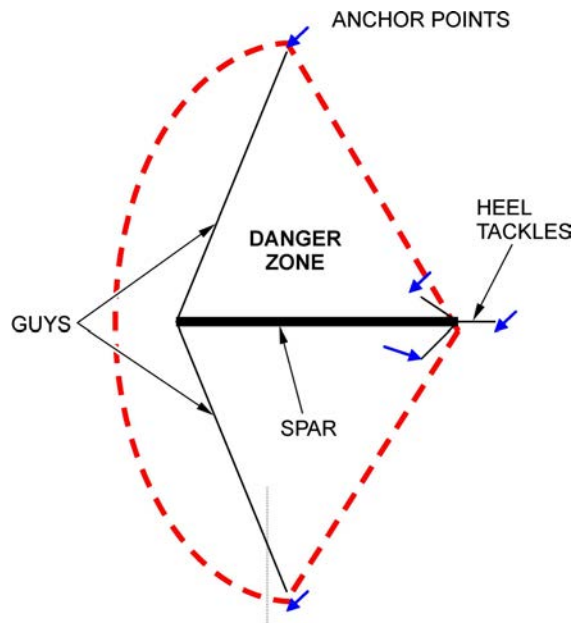

*Director Cadets 3, 2008, Ottawa, ON: Department of National Defence*

Figure 12-1-3 Standing Derrick Danger Zone

---

**CONFIRMATION OF TEACHING POINT 2**

---

**QUESTIONS**

- Q1. When do the forward and aft danger zones of the sheers become active?
- Q2. Why should care be taken when heaving in the splay tackles on the gyn?
- Q3. What should be done before hooking on or unhooking the load on the standing derrick?

**ANTICIPATED ANSWERS**

- A1. When the topping lift is heaved in.
- A2. The gyn may become unstable when it nears full height.
- A3. The topping lift should be checked away.

---

**END OF LESSON CONFIRMATION**

---

**QUESTIONS**

- Q1. When should personal safety equipment be worn?
- Q2. Why is the inside of the sheers a danger zone when the heel tackles are under tension?
- Q3. What are danger zones?

**ANTICIPATED ANSWERS**

- A1. At all times.
- A2. The spars may snap back along the ground if the splay or heel tackles fail.
- A3. Areas where there is a risk of injury due to a failure in the rigging equipment.

---

**CONCLUSION**

---

**HOMEWORK/READING/PRACTICE**

N/A.

**METHOD OF EVALUATION**

This EO is assessed IAW A-CR-CCP-603/PG-001, Chapter 3, Annex B, Appendix 4 (321 PC).

**CLOSING STATEMENT**

It is important to be familiar with the personal safety equipment, safe practices and danger zones while working with lifting devices as there is the potential for injury if safety procedures are not followed.

**INSTRUCTOR NOTES/REMARKS**

This EO shall be conducted prior to EO M321.02 (Rig Sheers, Section 2).

---

**REFERENCES**

---

- A1-004 B-GN-181-105/FP-E00 Chief of the Maritime Staff. (2000). *CFCD 105 Fleet Seamanship Rigging and Procedures Manual*. Ottawa, ON: Department of National Defence.
- C1-131 Navy League of Canada. (2008). *NLP 101 Flotilla and Provincial Seamanship Competition Manual*. Toronto, ON: Navy League of Canada.

THIS PAGE INTENTIONALLY LEFT BLANK



## ROYAL CANADIAN SEA CADETS

### PHASE THREE

### INSTRUCTIONAL GUIDE



### SECTION 2

### EO M321.02 – RIG SHEERS

---

Total Time: 150 min

---



---

### PREPARATION

---

#### PRE-LESSON INSTRUCTIONS

Resources needed for the delivery of this lesson are listed in the lesson specification located in A-CR-CCP-603/PG-001, Chapter 4. Specific uses for said resources are identified throughout the instructional guide within the TP for which they are required.

Review the lesson content and become familiar with the material prior to delivering the lesson.

Photocopy and cut out the parts cards located at Annex A.

Photocopy the blank sheers diagram located at Annex B, the sequence for Station 3 located at Annex C and the sheers scoresheet located at Annex D.

Ensure that the cadets have their issued cadet boots with them.

#### PRE-LESSON ASSIGNMENT

N/A.

#### APPROACH

An interactive lecture was chosen for TPs 1, 2 and 5 to present and illustrate the function, basic materials needed and the application of commands for rigging sheers.

Demonstration and performance was chosen for TPs 3, 4, 6 and 8 as it provides the instructor the opportunity to introduce sheers, demonstrate procedures and observe the cadets' rigging and de-rigging skills.

A practical activity was chosen for TP 7 as it is an interactive way to introduce the cadets to operating sheers in a safe and controlled environment. This activity contributes to the development of seamanship skills and teamwork in a fun and challenging setting.

---

### INTRODUCTION

---

#### REVIEW

Review safe practices, personal safety equipment and sheers danger zones from EO M321.01 (Describe Safety Procedures for Operating Lifting Devices, Section 1).

#### OBJECTIVES

By the end of this lesson the cadet shall, as a member of a group, rigged, operated and de-rigged sheers.

## IMPORTANCE

It is important for cadets to rig sheers as it introduces sea activities of the Canadian Navy while stimulating an interest in seamanship specialty training. Although sheers are no longer used regularly by the Canadian Navy, it is a great way to foster teamwork and practice seamanship skills.

---

### Teaching Point 1

### Explain the Function of Sheers

Time: 5 min

Method: Interactive Lecture

---

## SHEERS

Due to improvements in technology, improvised lifting devices are not as widely used today as in the past. However, when no suitable crane or hydraulic device is available on board or ashore for lifting a heavy object or equipment, some form of lifting device must be rigged. This may include sheers, a standing or swinging derrick or a gyn.

Sheers consist of a pair of spars called legs, which are lashed together and crossed near their heads. The heels of the spars are splayed apart a distance that is approximately one third the length of the spars used for the sheers. This splayed distance is maintained by the use of a splay tackle. The heel tackles provide firm tension on the heels and are placed in such a way to provide both lateral and fore-and-aft support. As sheers need no lateral support, side guys are not required.

Since sheers use two spars, they are stronger than a derrick of similar size. Sheers can be raised or lowered to a limited angle using a topping lift. Sheers are particularly suited for lifting loads vertically from the edge of a jetty onto the deck of a ship.

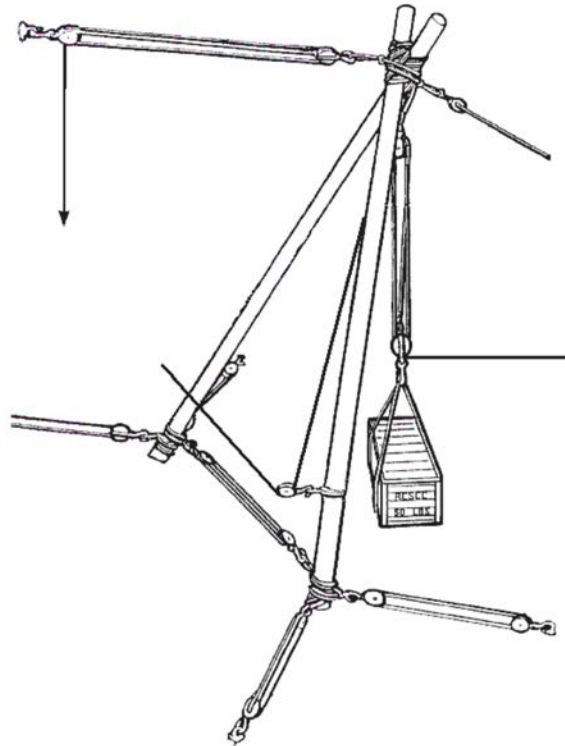

*Royal Navy, Admiralty Manual of Seamanship 1967 (Vol. 2), Her Majesty's Stationery Office (p. 197)*

Figure 12-2-1 Assembled Sheers



---

**CONFIRMATION OF TEACHING POINT 1**

---

**QUESTIONS**

- Q1. How many spars are required to rig sheers?
- Q2. What is the purpose of the splay tackle?
- Q3. When are sheers used?

**ANTICIPATED ANSWERS**

- A1. Two.
- A2. To maintain the distance that the spars are splayed.
- A3. For lifting loads vertically from the edge of a jetty onto the deck of a ship.

**Teaching Point 2****Describe the Parts of the Sheers**

Time: 10 min

Method: Interactive Lecture

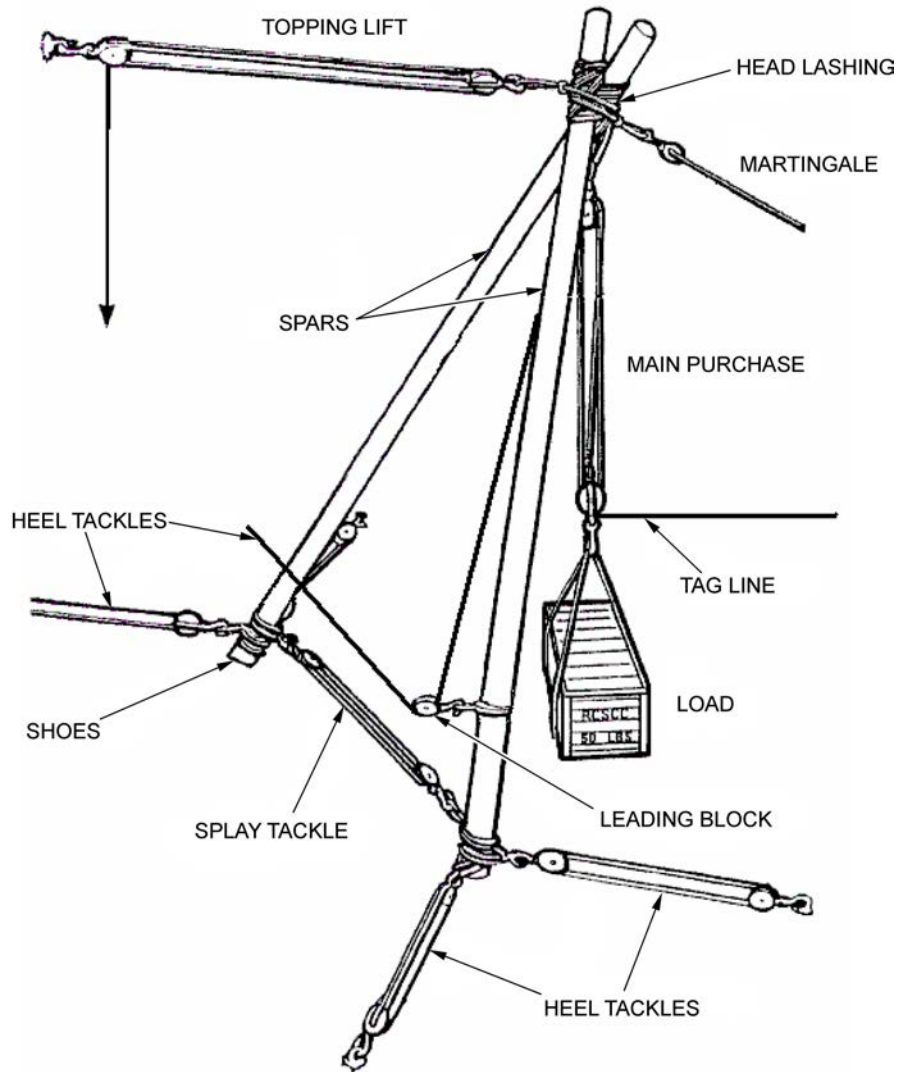
**PARTS OF THE SHEERS**

*Royal Navy, Admiralty Manual of Seamanship 1967 (Vol. 2), Her Majesty's Stationery Office (p. 197)*

Figure 12-2-2 Assembled Sheers

**Spars.** Two spars are used as the legs of the sheers. The spars are crossed and lashed together with a head lashing.

**Head Lashing.** The head lashing forms the head of the sheers. The spars are lashed together using 14 or more turns around both spars followed by four or more frapping turns through the upper and lower crutch that forms when the spars are splayed apart (as illustrated in Figure 12-2-3).

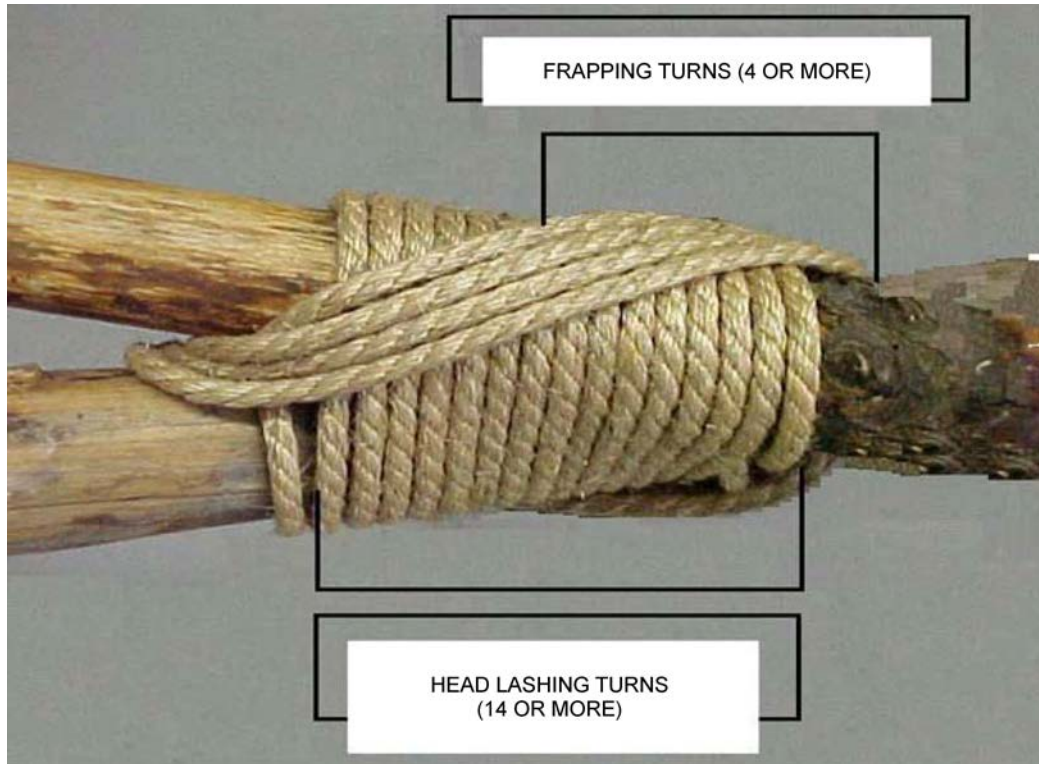

*Navy League of Canada, NLP 101 Flotilla and Provincial Seamanship Competition Manual, Navy League of Canada (p. 14)*

Figure 12-2-3 Sheers Head Lashing

**Topping Lift.** The topping lift, consisting of a two-fold purchase, is used to raise or lower the sheers. If no suitable overhead attachment point exists, the topping lift can be anchored to the deck or ground a minimum distance of one and a half spar lengths from the heel anchor points.



The sheers should not be raised to an angle greater than 75 degrees from the ground or deck. If the topping lift is anchored to the ground, the sheers should not be lowered to an angle less than 25 degrees from the ground.

**Main Purchase.** The main purchase, consisting of a two-fold purchase, is attached to the head of the sheers and is used to raise or lower the load.

**Strops.** Strops are a continuous loop in a line or wire rope. They are used to pass around a cask, spar, piece of line, etc to provide an eye to be placed over a hook or shackle (as illustrated in Figure 12-2-4).

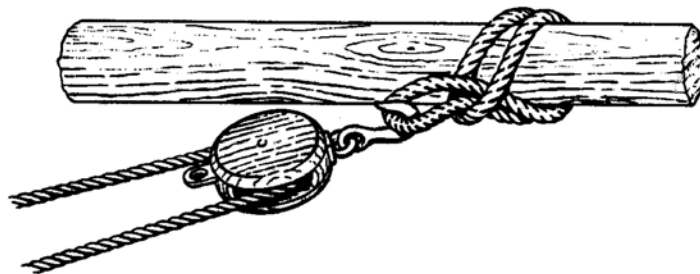

*Royal Navy, Admiralty Manual of Seamanship 1964 (Vol. 1), Her Majesty's Stationery Office (p. 193)*

Figure 12-2-4 Strop on a Spar

12-M321.02-5

**Leading Block (for the Fall of the Main Purchase).** The leading block is secured to one of the spars and the hauling part, or fall of the main purchase, is led through it. This block is used to change the direction of pull on the fall of the main purchase.



The fall of the main purchase refers to its hauling part which exits the standing block attached to the head of the sheers. The fall must be heaved in a downward motion, directly under the spars which would put a cadet within a danger zone. The leading block allows the line to be safely heaved in from the side of the sheers.

**Splay Tackle.** The splay tackle, consisting of a luff, prevents the spars from splaying – moving further apart – when they are under load.

**Heel Tackles.** The heel tackles, consisting of luffs, provide firm tension on the heels of the spars and also provide both lateral and fore-and-aft support.

**Tag Line.** A line, attached to the running block of the main purchase, used to retrieve the main purchase without stepping into the forward danger zone.

**Martingale (if Fitted).** If a suitable attachment point exists at the front of the sheers, a martingale may be led down from the head. This will prevent the sheers from springing up or back when hoisting and lowering a load.

**Shoes (if Fitted).** Shoes are usually square slabs of hardwood with a recess in their upper surface to take the heel of a spar. The length of each side should not be less than four times the diameter of the spar. They are used to distribute the weight of the load and the thrust of the spars over an area of the deck. When ashore, they are used to distribute the weight to prevent the spars from sinking into the ground.

---

## CONFIRMATION OF TEACHING POINT 2

---

### QUESTIONS

- Q1. What is the purpose of the topping lift?
- Q2. How many turns are required for the sheers head lashing?
- Q3. Why is a leading block used for the fall of the main purchase?

### ANTICIPATED ANSWERS

- A1. To raise or lower the sheers.
- A2. 14 or more.
- A3. To redirect the hauling part so it may be heaved in from the side of the sheers.

---

### Teaching Point 3

### Demonstrate and Have the Cadets Tie a Timber Hitch

Time: 20 min

Method: Demonstration and Performance

---

### TIMBER HITCH

#### Use of a Timber Hitch

The timber hitch is used to tow, hoist or lower a spar. The more tension placed on the hitch, the more it will hold the spar. When the tension is released, the hitch will loosen.

To add directional stability or when tying the hitch to a tapered spar, an extra half hitch should be added beside the timber hitch on the side facing the direction of pull.

### How to Tie a Timber Hitch



Demonstrate and have the cadets practice each step of making the timber hitch.

1. Pass the working end of a line around the spar and bring it to the front.

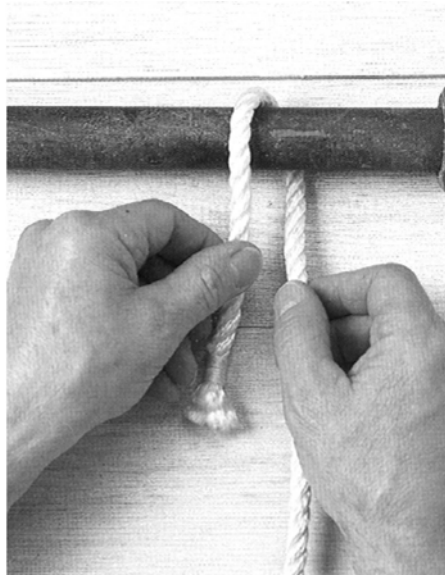

*G. Budworth, The Ultimate Encyclopedia of Knots & Ropework, Anness Publishing Limited (p. 98)*

Figure 12-2-5 Timber Hitch Step 1

2. Take the end around the standing part and make a small loop.

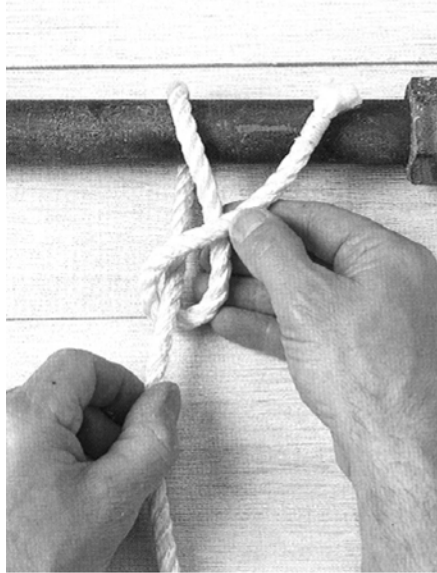

*G. Budworth, The Ultimate Encyclopedia of Knots & Ropework, Anness Publishing Limited (p. 98)*

Figure 12-2-6 Timber Hitch Step 2

3. Tuck the working end between the standing end and itself.

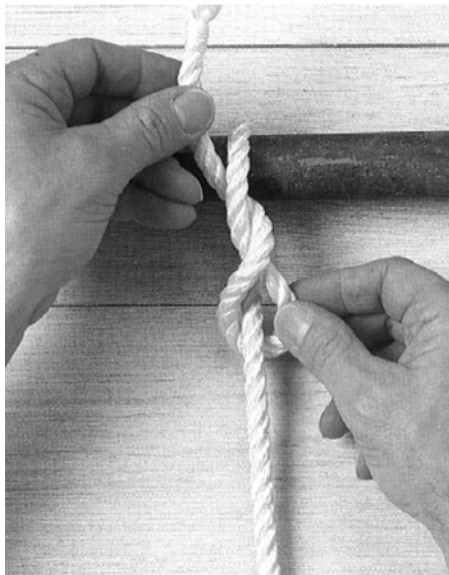

*G. Budworth, The Ultimate Encyclopedia of Knots & Ropework, Anness Publishing Limited (p. 98)*

Figure 12-2-7 Timber Hitch Step 3

4. Bring the end around and repeat Step 3 until the required number of tucks are completed (minimum of three).

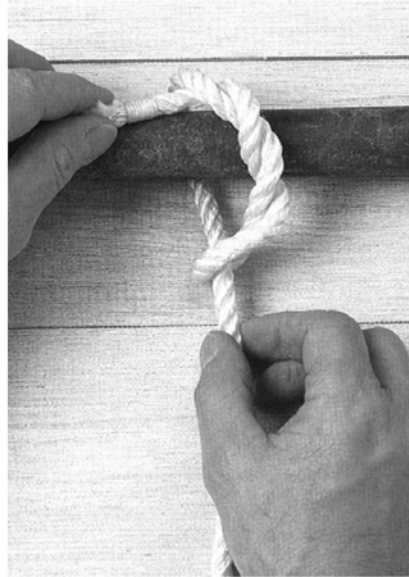

*G. Budworth, The Ultimate Encyclopedia of Knots & Ropework, Anness Publishing Limited (p. 98)*

Figure 12-2-8 Timber Hitch Step 4

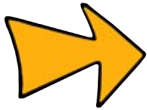

Tucking in this fashion, to make a sliding noose, is known as “dogging”.

5. Pull on the standing end to tighten the hitch around the spar.



*G. Budworth, The Ultimate Encyclopedia of Knots & Ropework, Anness Publishing Limited (p. 98)*

Figure 12-2-9 Completed Timber Hitch

---

### CONFIRMATION OF TEACHING POINT 3

---

The cadets tying a timber hitch will serve as the confirmation of this TP.

**Teaching Point 4****Demonstrate and Have the Cadets Choke a Luff**

Time: 20 min

Method: Demonstration and Performance

**CHOKING A LUFF**

Demonstrate and have the cadets practice choking a luff.

To temporarily secure a luff under tension when there is no cleat available, the hauling part is passed underneath its adjacent running part where it fouls, or chokes, the block. Two half hitches may be added above the block to ensure that the choke does not slip.

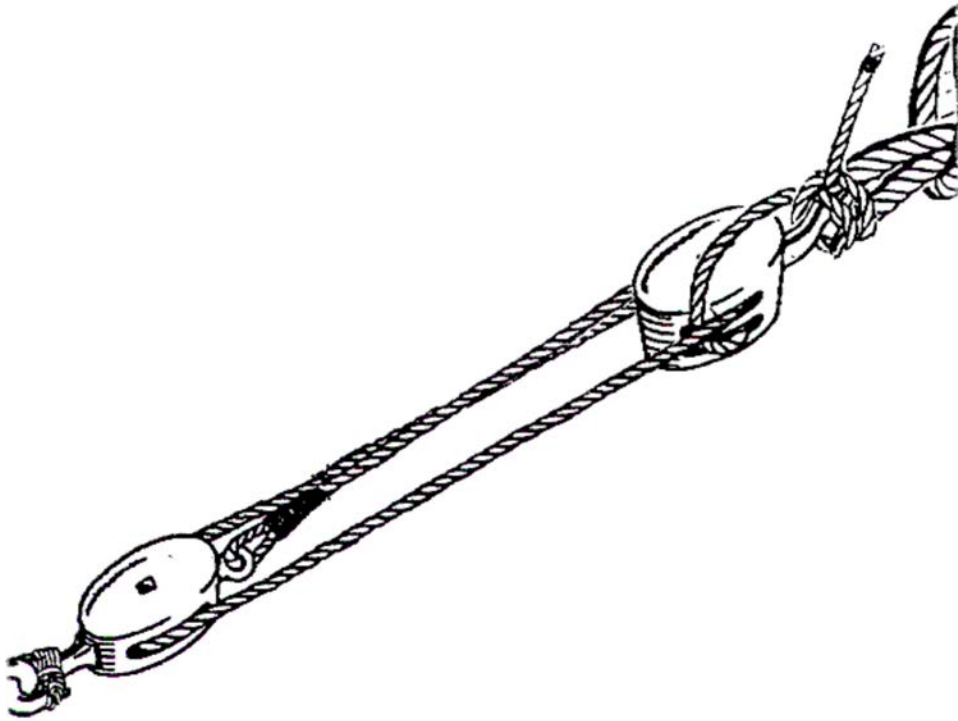

*Navy League of Canada, NLP 101 Flotilla and Provincial Seamanship Competition Manual, Navy League of Canada (p. 13)*

Figure 12-2-10 Choking a Luff



This method should be used with luffs under light loads only, as damage to the rope may occur if the load is too heavy.

**CONFIRMATION OF TEACHING POINT 4**

The cadets choking a luff will serve as the confirmation of this TP.



**Teaching Point 5****Describe the Actions Taken in Response to Commands**

Time: 15 min

Method: Interactive Lecture

**COMMANDS****Heave in.** Give a strong pull together on a line.**Check Away.** Ease out a line under control.**Avast.** Stop.**Choke.** Choke the standing block with the hauling part and secure it with two half hitches above the crown.**Secure.** Make fast a line.**Handsomely.** Slowly, carefully.**Roundly.** Rapidly.

These are the most commonly used commands for working with sheers; however, the list is not exhaustive. Other commands may be used based on unit preferences.

**CONFIRMATION OF TEACHING POINT 5****QUESTIONS**

Q1. What does the order HEAVE IN mean?

Q2. What order is given to make fast a line?

Q3. What does the order AVAST mean?

**ANTICIPATED ANSWERS**

A1. Give a strong pull together on a line.

A2. SECURE.

A3. Stop.

**Teaching Point 6****Demonstrate and Have the Cadets, as Members of a Group, Rig Sheers**

Time: 20 min

Method: Demonstration and Performance

**RIGGING SHEERS**

Demonstrate and have the cadets practice the steps for rigging sheers.

1. Lay the spars for the legs side by side, with their heels together and their heads supported clear of the ground or deck.
2. Start the head lashing with a timber hitch on one of the spars followed by 14 or more turns around both spars. Spread the spars apart to allow four or more frapping turns to pass around the spars and through the crutch formed above and below the spars (as illustrated in Figure 12-2-3). Finish the head lashing with a clove hitch on the spar opposite to the timber hitch. Once the head lashing is complete, splay the heels of the spars apart to a distance of one third the length of the spars used for the sheers.
3. Place the main purchase strop around the head lashing, following the path of the frapping turns (as illustrated in Figure 12-2-11). Ensure the bight of the strop is pointed down between the spars.
4. Place the topping lift strop around the head lashing and main purchase strop (as illustrated in Figure 12-2-11). Ensure the bight of the strop is pointed up from the head.



*Navy League of Canada, NLP 101 Flotilla and Provincial Seamanship Competition Manual, Navy League of Canada (p. 14)*

Figure 12-2-11 Topping Lift and Main Purchase Strops

5. Rig the main purchase using a two-fold purchase (as illustrated in Figure 12-2-12). Attach the standing block to the main purchase strop (as illustrated in Figure 12-2-11) ensuring that the main purchase is rigged to disadvantage with the hauling part exiting the standing block. Attach the tag line to the running block and lay it out so an end will be outside the danger zone when the sheers are raised.
6. Rig the topping lift using a two-fold purchase (as illustrated in Figure 12-2-12). Attach the standing block to the topping lift anchor point and the running block to the topping lift strop. Ensure the topping lift is rigged to disadvantage with the hauling part exiting the standing block. Tie a figure eight knot in the end of the hauling part.

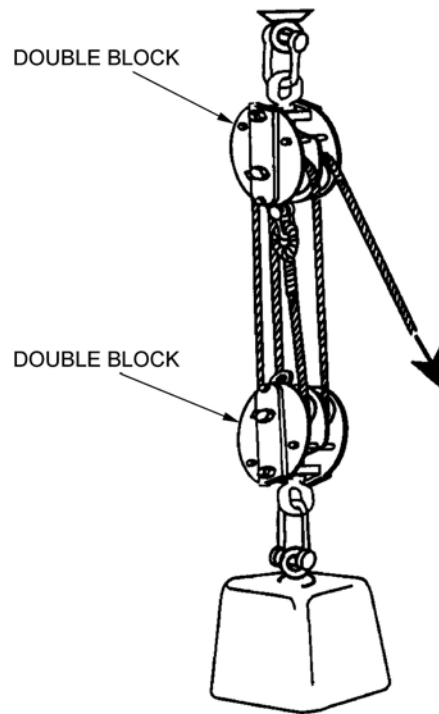

BON-050-002/PT-004, BR 67 Admiralty Manual of Seamanship (p. 3-155)

Figure 12-2-12 Two-Fold Purchase

7. Attach strops to the feet of the spars (as illustrated in Figure 12-2-14) for the leading block, splay and heel tackles. Attach the splay tackle strops between the strops for the heel tackles. Attach the leading block strop above or between the heel tackle strops. Ensure the strops are placed together, as low as possible but no lower than one hands-width above the heels.



Placing the leading block strop between the heel tackle strops will stop it from sliding up the spar when the fall is heaved in.

8. Hook the leading block on to the strop. Reeve the fall of the main purchase through the leading block and tie a figure eight knot in the end. Coil the excess line and place it on the deck outside the danger zone, on the opposite side of the sheers from the side where the leading block is attached.
9. Rig the splay tackle using a luff (as illustrated in Figure 12-2-13) and attach to the strops between the spars and under the topping lift. Tie a figure eight knot in the end of the hauling part. Heave in the splay tackle to splay the heels of the spars apart to a distance approximately one third the length of the spars used for the sheers. Choke and secure the splay tackle. Coil any excess line and place it on the deck.
10. Rig the heel tackles using luffs (as illustrated in Figure 12-2-13) and attach to the strops and anchor points. Ensure that all heel tackles are rigged to advantage with the hauling parts exiting the running blocks attached to the spars (as illustrated in Figure 12-2-14). Tie a figure eight knot in the end of the hauling part.

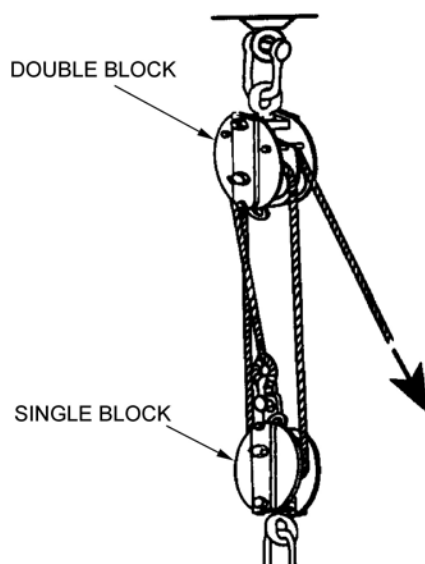

BON-050-002/PT-004 (p. 3-155)

Figure 12-2-13 Luff

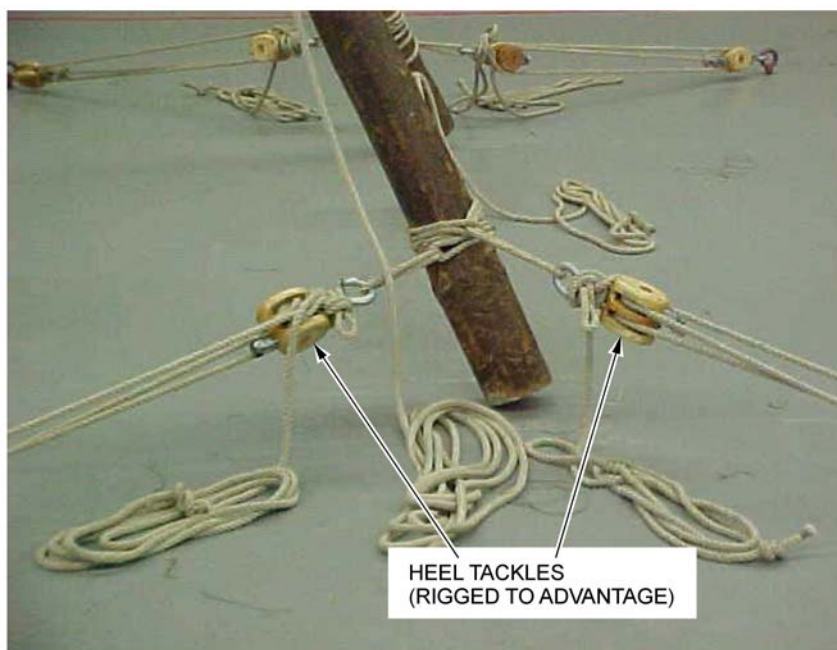

Navy League of Canada, NLP 101 Flotilla and Provincial Seamanship Competition Manual, Navy League of Canada (p. 14)

Figure 12-2-14 Heel Tackles Rigged to Advantage

11. Mouse all hooks (as illustrated in Figure 12-2-15).

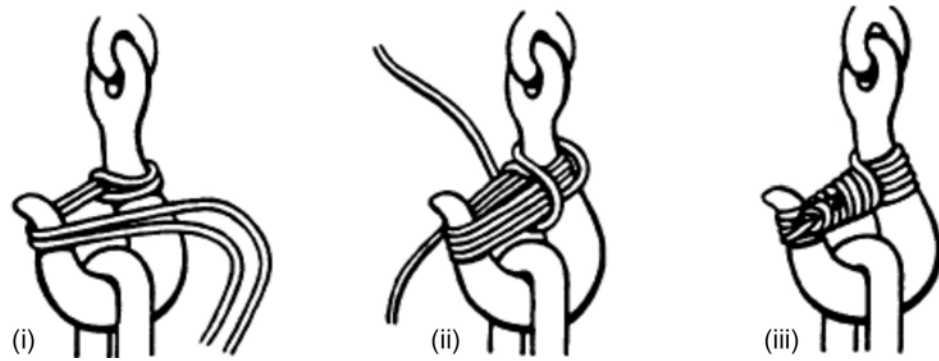

B-GN-181-105/FP-E00, CFCD 105 Seamanship Rigging and Procedures Manual (p. 5-46)

Figure 12-2-15 Mousing a Hook



Mousing is not required for blocks equipped with a safety catch on the hook. If the safety catch has been removed or the spring is missing from the catch, the block must be replaced.

12. Heave in all heel tackles until they are evenly taut. Choke and secure them with two half hitches. Coil any excess line and place neatly on the deck. If the sheers are not positioned correctly, they can be adjusted by heaving in or checking away the individual heel tackles.



To adjust the position of the sheers, stand at the head facing the heels and use the following sequence:

1. Adjust the side-to-side position of the sheers by heaving in evenly on both heel tackles on the side the sheers are to move toward while checking away handsomely on the opposite heel tackles. When the sheers reach the correct position, avast checking away.
2. Adjust the fore-and-aft position of the sheers by heaving in evenly on both forward heel tackles (tackles closest to the head) while checking away handsomely on the after heel tackles. When the sheers reach the correct position, avast checking away.
3. Adjust the head of the sheers so that it is centred between the heels by heaving in on the after heel tackle on the side the head is to move towards while checking away handsomely on the opposite side's forward heel tackle. When the head is in the correct position, avast checking away.
4. Choke all heel tackles and secure them with two half hitches above the blocks.

13. Heave in on the topping lift handsomely until the sheers have been raised to an angle between 25 and 75 degrees from the floor. Choke and secure the topping lift.



If the topping lift is anchored to the deck, the head of the sheers must be picked up and held at chest height until the topping lift becomes taut. The person at the head of the sheers shall then step out of the danger zone.

14. Heave in on the tag line to pull the running block out of the danger zone, checking away on the fall of the main purchase if required. Secure the fall of the main purchase to the spar opposite the leading block with a round turn and two half hitches.
15. The sheers are now complete and ready for operation (as illustrated in Figure 12-2-2).

---

### CONFIRMATION OF TEACHING POINT 6

---

The cadets' participation in rigging sheers will serve as the confirmation of this TP.

---

#### Teaching Point 7

#### Have the Cadets, as Members of a Group, Operate the Sheers

Time: 40 min

Method: Practical Activity



Demonstrate how to operate the sheers prior to starting the activity.

---

### ACTIVITY

---

#### OBJECTIVE

The objective of this activity is to have the cadets, as members of a group, operate the sheers.

#### RESOURCES



The list of required equipment for the sheers is located at A-CR-CCP-603/PG-001, Chapter 2, Annex C, Appendix 1.

When choosing the equipment for rigging the sheers, ensure that each item is compatible with the others (e.g., the blocks are suitable for the size of the line).

- Assembled sheers,
- Load of 22 kg (50 lbs) or less,
- Whipping twine,
- Pylons,
- Hooks,
- Hard hats,
- Parts cards located at Annex A,
- Picture/model of sheers (blank picture located at Annex B),
- Sequence for Station 3 located at Annex C,
- Scoresheet located at Annex D,
- Whistle, and

- Stopwatch.

### ACTIVITY LAYOUT

- Mark off a start area.
- Set up the start area with various pieces of safety equipment.
- Set up Station 1 with whipping twine and hooks.
- Set up Station 2 with parts cards, tape and a picture/model of sheers.
- Set up Station 3 with the sheers, whipping twine and a load.



The sheers at Station 3 shall be fully rigged (as illustrated in Figure 12-2-1). If no overhead mounting point is available, anchor the topping lift at least one and one-half spar lengths back from the heel tackle anchors.

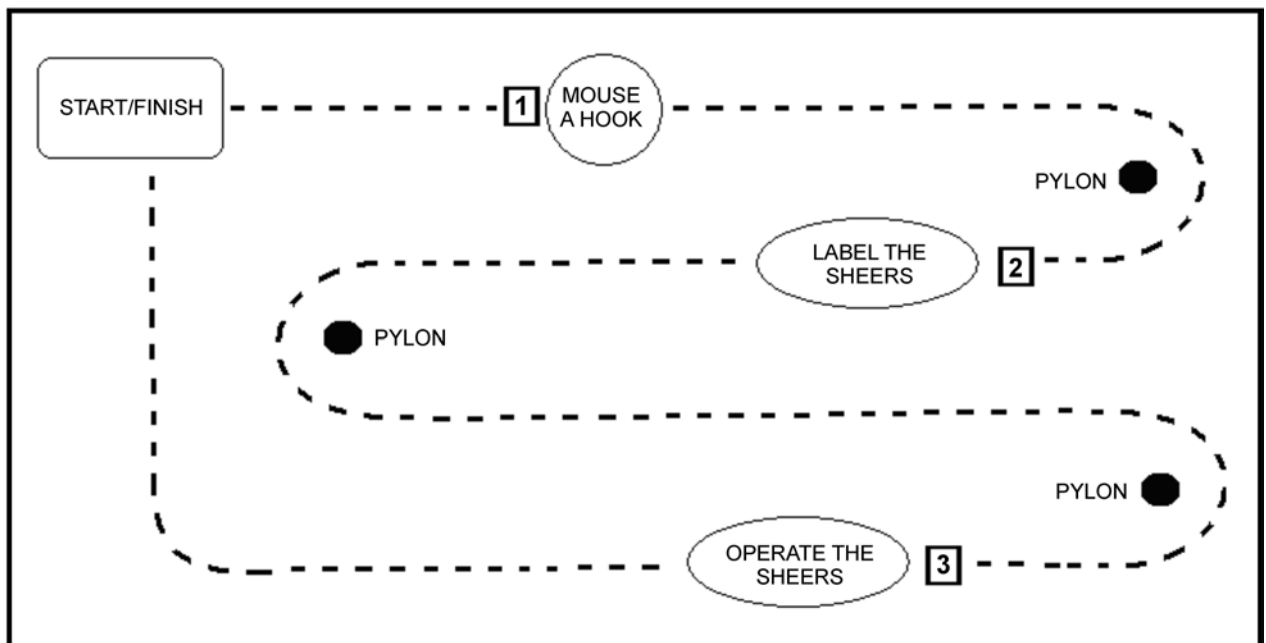

*Director Cadets 3, 2008, Ottawa, ON: Department of National Defence*

Figure 12-2-16 Sheers Run

### ACTIVITY INSTRUCTIONS

1. Divide the cadets into groups of four.
2. Have the first group line up in the start area.
3. On the whistle signal, have the group put on their personal safety equipment and proceed to Station 1.



Ensure the time is started on the stopwatch at the whistle signal.



4. At Station 1, have each cadet in the group mouse a hook. Check the mousings for strength. If any of the mousings come off easily, that cadet will do another mousing. Upon successfully completing the mousings, have the group proceed to Station 2.
5. At Station 2, have the group label the picture/model of the sheers and then proceed to Station 3.
6. At Station 3, stop and record the time. Have the group operate the sheers by responding to commands listed at Annex C, as given by the instructor. Award points IAW the scoresheet located at Annex D.
7. Upon completion of Station 3, have the group continue to the finish line and tally the score.
8. Have each group complete the sheers run in the above sequence.
9. Declare the group with the most points the winner.

### **SAFETY**

- Ensure the personal safety equipment is worn at all times.
- Ensure the cadets stay outside the danger zones while the sheers are raised.
- Ensure all hooks are moused or fitted with working safety catches.

---

### **CONFIRMATION OF TEACHING POINT 7**

---

The cadet's participation in the activity will serve as the confirmation of this TP.

---

### **Teaching Point 8**

### **Demonstrate and Have the Cadets, as Members of a Group, De-Rig Sheers**

Time: 10 min

Method: Demonstration and Performance

---

### **DE-RIGGING SHEERS**



Demonstrate and have the cadets practice each step in de-rigging sheers.

1. Check away on the topping lift handsomely until the head of the sheers is resting on the deck. When the sheers near the deck, it is permissible to step into the danger zone to grab the head of the sheers and lower it by hand.
2. Release the choke on the heel tackles, being careful not to place hands in the running parts of the luffs.



Once the head is on the ground and the tension has been released from the heel tackles, the sheers are safe to de-rig.

3. Cut any mousings that have been applied and unhook the blocks from the strops.
4. Un-reeve the heel, splay, main purchase and topping lift tackles.
5. Remove the strops from the spars.
6. Untie the head lashing.



7. Coil all lines and secure the equipment as required.

---

### CONFIRMATION OF TEACHING POINT 8

---

The cadets' participation in de-rigging sheers will serve as the confirmation of this TP.

---

### END OF LESSON CONFIRMATION

---

The cadets' rigging, operating and de-rigging sheers will serve as the confirmation of this lesson.

---

### CONCLUSION

---

### HOMEWORK/READING/PRACTICE

N/A.

### METHOD OF EVALUATION

This EO is assessed IAW A-CR-CCP-603/PG-001, Chapter 3, Annex B, Appendix 4 (321 PC).

### CLOSING STATEMENT

Rigging sheers requires teamwork. Sheers are a device that has many practical uses within the Canadian Navy, although it is not used as frequently today as in years past due to improvements in technology. Rigging sheers acts as an introduction to sea activities of the Canadian Navy while stimulating an interest in seamanship specialty training.

### INSTRUCTOR NOTES/REMARKS

This EO shall be conducted after EO M321.01 (Describe Safety Procedures for Operating Lifting Devices, Section 1).

This EO may be conducted as five consecutive periods on a weekend training day or over two training nights. Training night one will consist of TPs 1–4 for a total of two periods. Training night two will consist of TPs 5–8 for a total of three periods.

---

### REFERENCES

---

- C1-003 (ISBN II 770973 5) Royal Navy. (1972). *Admiralty Manual of Seamanship 1964* (Vol. 1). London, England: Her Majesty's Stationery Office.
- C1-049 (ISBN 0-11-771958-7) Royal Navy. (1967). *Admiralty Manual of Seamanship 1967* (Vol. 2). Cambridge, England: Her Majesty's Stationery Office.
- C1-064 (ISBN 1-55267-986-1) Budworth, G. (2001). *The Ultimate Encyclopedia of Knots & Ropework*. London, England: Anness Publishing Limited.
- C1-131 Navy League of Canada. (2008). *NLP 101 Flotilla and Provincial Seamanship Competition Manual: Sheers*. Toronto, ON: Navy League of Canada.

THIS PAGE INTENTIONALLY LEFT BLANK



## ROYAL CANADIAN SEA CADETS

### PHASE THREE

### INSTRUCTIONAL GUIDE



### SECTION 3

### EO C321.02 – RIG A STANDING DERRICK

Total Time:

150 min

### PREPARATION

#### PRE-LESSON INSTRUCTIONS

Resources needed for the delivery of this lesson are listed in the lesson specification located in A-CR-CCP-603/PG-001, Chapter 4. Specific uses for said resources are identified throughout the instructional guide within the TP for which they are required.

Review the lesson content and become familiar with the material prior to delivering the lesson.

Photocopy and cut out the parts cards located at Annex E.

Photocopy the blank standing derrick diagram located at Annex F, the sequence for Station 3 located at Annex G and the standing derrick scoresheet located at Annex H.

Ensure that the cadets have their issued cadet boots with them.

#### PRE-LESSON ASSIGNMENT

N/A.

#### APPROACH

An interactive lecture was chosen for TPs 1–3 to illustrate the function, parts and rigging commands for a standing derrick.

Demonstration and performance was chosen for TPs 4 and 6 as it provides the instructor the opportunity to introduce a standing derrick, demonstrate procedures and observe the cadets rigging and de-rigging a standing derrick.

A practical activity was chosen for TP 5 as it is an interactive way to introduce the cadets to operating a standing derrick in a safe and controlled environment. This activity contributes to the development of seamanship skills and knowledge in a fun and challenging setting.

### INTRODUCTION

#### REVIEW

Review EO M321.01 (Describe Safety Procedures for Operating Lifting Devices, Section 1).

## **OBJECTIVES**

By the end of this lesson the cadet shall, as a member of a group, rigged, operated and de-rigged a standing derrick.

## **IMPORTANCE**

It is important for cadets rig a standing derrick as it introduces them to sea activities of the Canadian Navy while stimulating an interest in seamanship specialty training. Although the standing derrick is no longer used regularly by the Canadian Navy, it is a great way to foster teamwork and practice seamanship skills.

---

### **Teaching Point 1**

### **Explain the Function of a Standing Derrick**

Time: 5 min

Method: Interactive Lecture

---

## **STANDING DERRICK**

Due to improvements in technology, improvised lifting devices are not as widely used today as in the past. However, when no suitable crane or hydraulic device for lifting a heavy object or equipment is available on board or ashore, some form of lifting device must be rigged. This may include sheers, a standing or swinging derrick or a gyn.

A standing derrick is effective in situations that require the load to be hoisted and moved laterally a short distance from the lifting point. It can be rigged with less equipment than other lifting devices as only one spar is required.

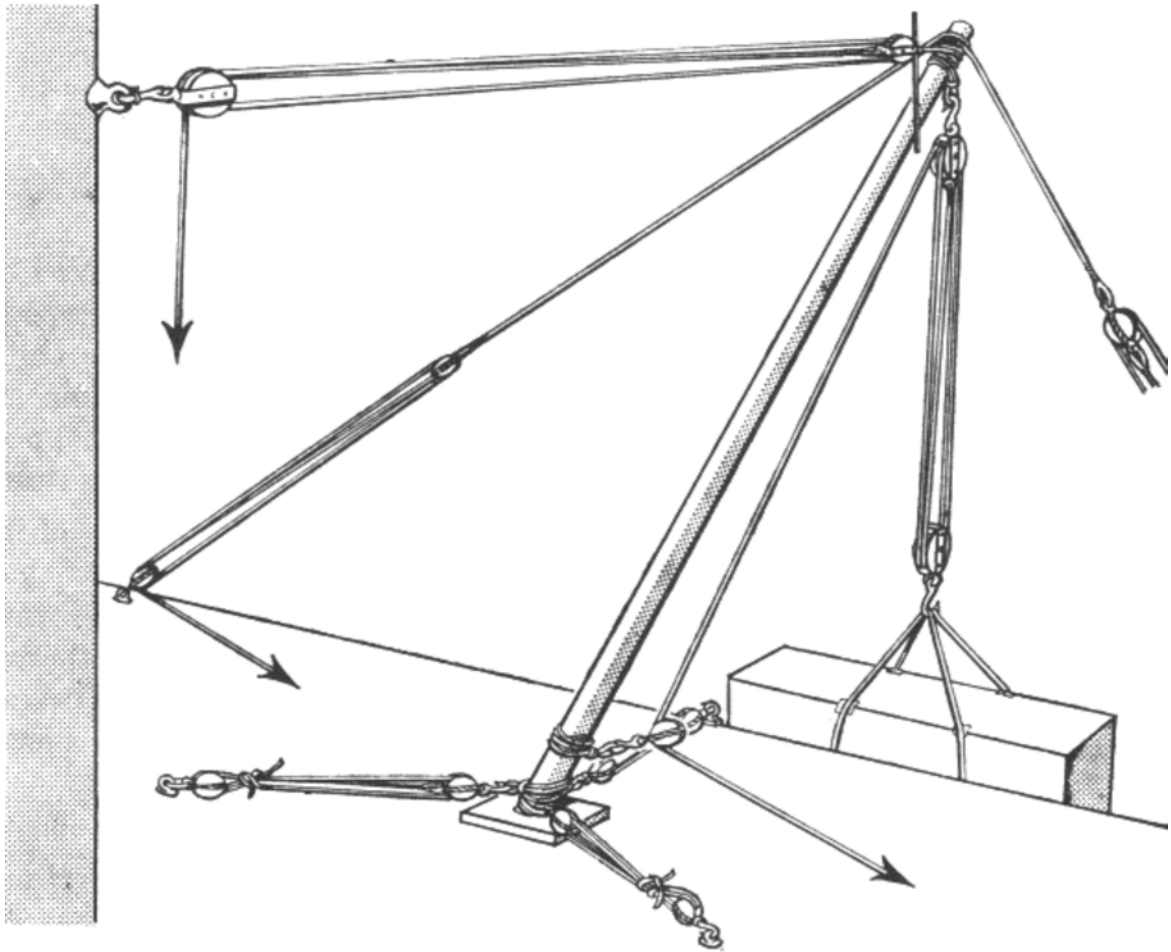

*Royal Navy, Admiralty Manual of Seamanship 1967 (Vol. 2), Her Majesty's Stationery Office (p. 195)*

Figure 12-3-1 Standing Derrick

---

### CONFIRMATION OF TEACHING POINT 1

---

#### QUESTIONS

- Q1. When is a standing derrick used?
- Q2. How many spars are required to rig a standing derrick?
- Q3. What is a standing derrick used for?

#### ANTICIPATED ANSWERS

- A1. When no suitable crane or hydraulic device is available on board or ashore.
- A2. One.
- A3. Hoisting and moving loads laterally a short distance.

**Teaching Point 2****Identify the Parts of a Standing Derrick**

Time: 15 min

Method: Interactive Lecture

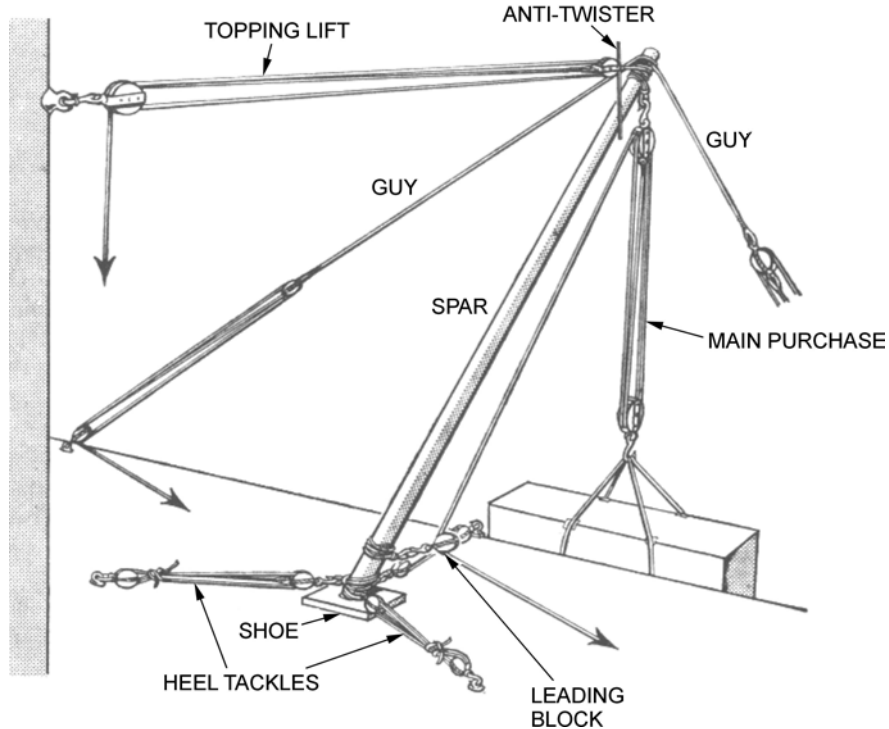
**PARTS OF A STANDING DERRICK**

*Royal Navy, Admiralty Manual of Seamanship 1967 (Vol. 2), Her Majesty's Stationery Office (p. 195)*

Figure 12-3-2 Parts of a Standing Derrick

**Topping Lift.** The topping lift, consisting of a two-fold purchase, is used to raise or lower the standing derrick. If no suitable overhead attachment point exists, the topping lift can be anchored to the deck or ground a minimum distance of one and a half spar lengths from the heel anchor points.



If the topping lift is anchored to the ground, the standing derrick should not be lowered to an angle less than 25 degrees from the ground.

**Side Guys.** The side guys, consisting of luffs attached to a snorter at the head of the spar, are fitted to give lateral support. The snorter's length will determine how far the standing derrick may slew from side-to-side using the side guys.

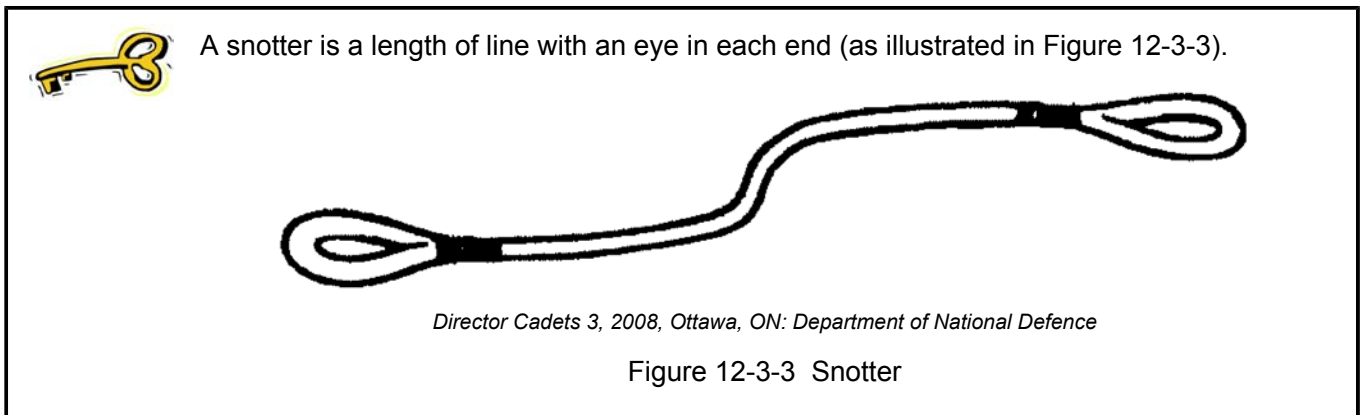

**Main Purchase.** The main purchase, consisting of a two-fold purchase, is attached to the head of the spar and is used to raise or lower the load.

**Spar.** The spar is the main support system for the standing derrick. The side guys, topping lift and the main purchase are attached to the spar.

**Anti-Twister.** An optional piece of wood that is attached to the strop at the block of the topping lift used to prevent the topping lift from twisting.

**Strops.** Strops are a continuous loop in a line or wire rope. They are used to pass around a cask, spar, piece of line, etc to provide an eye to be placed over a hook or shackle (as illustrated in Figure 12-3-4).

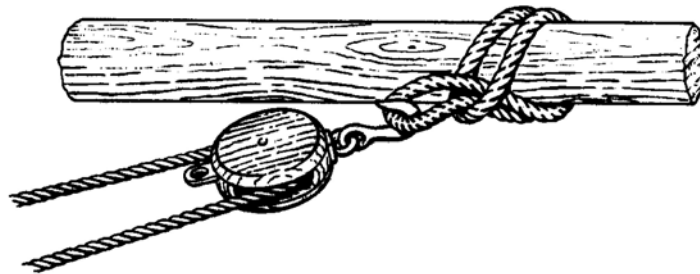

*Royal Navy, Admiralty Manual of Seamanship 1964 (Vol. 1), Her Majesty's Stationery Office (p. 193)*

Figure 12-3-4 Strop on a Spar

**Leading Block (for the Fall of the Main Purchase).** The leading block is secured to the heel of the spar and the hauling part, or fall of the main purchase, is led through it. This block is used to change the direction of pull on the fall of the main purchase.

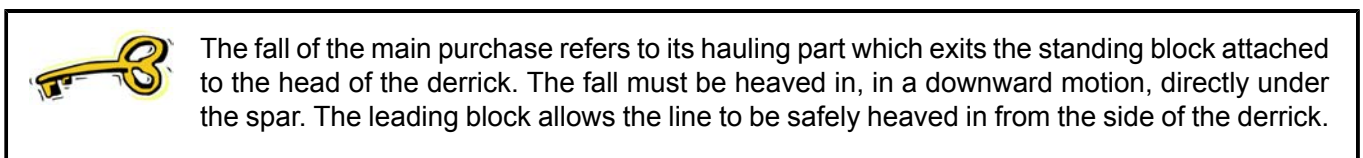

**Heel Tackles.** The heel tackles, consisting of luffs, are used to prevent the heel from moving.

**Tag Line.** A line, attached to the running block of the main purchase, used to retrieve the main purchase without stepping into the danger zone.

**Martingale (Fore Guy) (if Fitted).** If a suitable attachment point exists at the front of the standing derrick, a martingale or fore guy may be led down from the spar (not illustrated in Figure 12-3-2). This will prevent the spar from springing up or back when hoisting and lowering a load.

**Shoe (if Fitted).** The shoe is usually a square slab of hardwood with a recess in its upper surface to take the heel of a spar. The length of each side should not be less than four times the diameter of the spar. It is used to distribute the weight of the load and the thrust of the spar over an area of the deck. When ashore, it is used to distribute the weight to prevent the spar from sinking into the ground.

**Thumb Pieces/Rope Collars (if Fitted).** Thumb pieces/rope collars are used to prevent the strops from slipping on the spars (as illustrated in Figure 12-3-5). Thumb pieces are wooden pieces that are screwed or nailed to the spar. Rope collars are put onto the spar like a whipping.

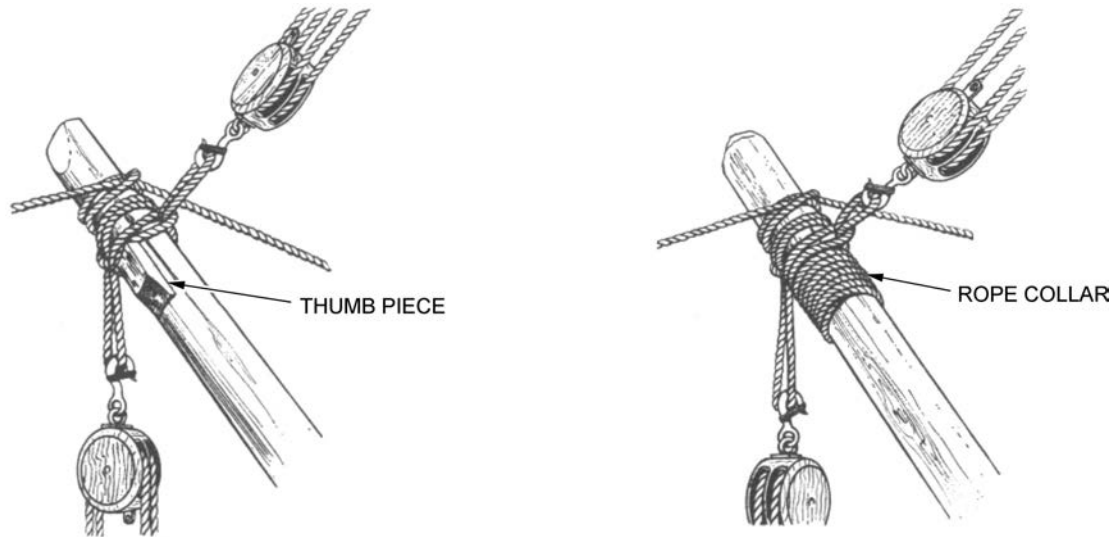

*Royal Navy, Admiralty Manual of Seamanship 1967 (Vol. 2), Her Majesty's Stationery Office (p. 207)*

Figure 12-3-5 Thumb Piece and Rope Collar

---

## CONFIRMATION OF TEACHING POINT 2

---

### QUESTIONS

- Q1. What is the minimum angle that the standing derrick may be lowered to when the topping lift is anchored to the floor?
- Q2. What is the purpose of a martingale or fore guy?
- Q3. What are heel tackles used for?

### ANTICIPATED ANSWERS

- A1. 25 degrees.
- A2. To prevent the spar from springing up or back when hoisting and lowering a load.
- A3. To prevent the heel from moving.



**Teaching Point 3****Describe the Action Taken in Response to Commands**

Time: 15 min

Method: Interactive Lecture

**COMMANDS****Heave in.** Give a strong pull together on a line.**Check Away.** Ease out a line under control.**Avast.** Stop.**Choke.** Choke and secure the tackle(s).**Secure.** Make fast a line.**Handsomely.** Slowly, carefully.**Roundly.** Rapidly.

These are the most commonly used commands for working with the standing derrick; however, the list is not exhaustive. Other commands may be used based on unit preferences.

**CONFIRMATION OF TEACHING POINT 3****QUESTIONS**

Q1. What does the order HEAVE IN mean?

Q2. What order is given to make fast a line?

Q3. What does the order AVAST mean?

**ANTICIPATED ANSWERS**

A1. Give a strong pull together on a line.

A2. SECURE.

A3. Stop.

**Teaching Point 4****Demonstrate and Have the Cadets, as Members of a Group, Rig a Standing Derrick**

Time: 20 min

Method: Demonstration and Performance

**RIGGING A STANDING DERRICK**

Demonstrate and have the cadets practice each step in rigging the standing derrick.

1. Place the strops for the main purchase and topping lift over the head of the spar. Attach thumb pieces/rope collars to prevent the strops from slipping (as illustrated in Figure 12-3-5). Lay the strops close together to avoid a bending stress on the spar.
2. Rig the main purchase using a two-fold purchase (as illustrated in Figure 12-3-6). Attach the standing block to the main purchase strop. Ensure that the main purchase is rigged to disadvantage with the hauling part, or fall, exiting the standing block. Attach the tag line to the running block and lay it out so an end will be outside of the danger zone when the standing derrick is raised.
3. Rig the topping lift using a two-fold purchase. Attach the standing block to the topping lift anchor point and the running block to the topping lift strop. Ensure that the topping lift is rigged to disadvantage with the hauling part exiting the standing block. Tie a figure eight knot in the end of the hauling part.

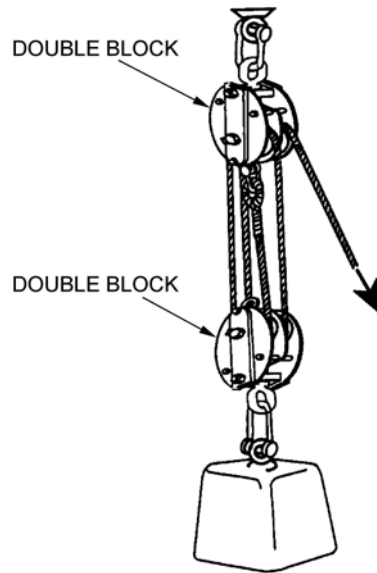

BON-050-002/PT-004 (p. 3-155)

Figure 12-3-6 Two-Fold Purchase

4. Attach a snotter over the head of the spar, above the strops, using a clove hitch. Ensure that the eyes of the snotter extend equally from the spar. Rig the side guys using luffs (as illustrated in Figure 12-3-7). Attach the running blocks to the eyes in the snotter and the standing block to the side guys anchor point. Ensure that the side guys are rigged to disadvantage with the hauling parts exiting the standing blocks. Tie figure eight knots in the end of the hauling parts.

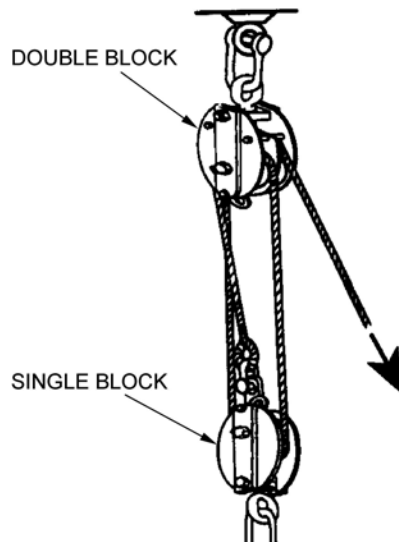

BON-050-002/PT-004 (p. 3-155)

Figure 12-3-7 Luff

5. Place the foot of the spar in a shoe if one is fitted.
6. Rig the heel tackles using luffs. Attach the standing blocks to the heel strops and the running blocks to the heel tackle anchor points. Ensure that the heel tackles are rigged to disadvantage with the hauling parts exiting the standing blocks. Tie a figure eight knot in the end of the hauling part.
7. Attach the leading block strop to the foot of the spar. Hold the strop in place with a thumb piece/rope collar. Reeve the fall of the main purchase through the leading block, tie a figure eight knot in the end and coil the excess line to one side of the spar.
8. Mouse all hooks (as illustrated in Figure 12-3-8).

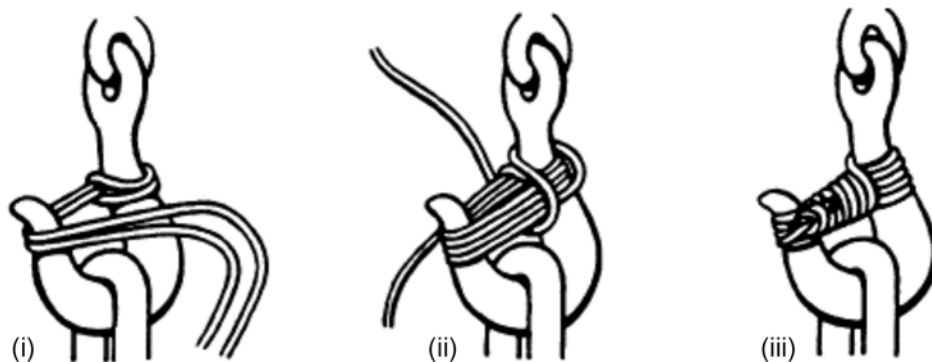

B-GN-181-105/FP-E00 (p. 5-46)

Figure 12-3-8 Mousing a Hook



Mousing is not required for blocks equipped with a safety catch on the hook. If the safety catch has been removed or the spring is missing from the catch, the block must be replaced.

9. Heave in all heel tackles until they are evenly taut. Choke and secure the heel tackles. Coil any excess line and place neatly on the deck.

10. Heave in on the topping lift handsomely until the standing derrick has been raised to an angle between 25 and 75 degrees from the floor. Choke and secure the topping lift.



If the topping lift is anchored to the deck, the head of the spar must be picked up and held at chest height until the topping lift becomes taut. The person at the head of the spar shall then step out of the danger zone.

11. Heave in on the tag line to pull the running block out of the danger zone, checking away on the fall of the main purchase, if required.
12. The standing derrick is now complete and ready for operation (as illustrated in Figure 12-3-2).

---

#### CONFIRMATION OF TEACHING POINT 4

---

The cadets' participation in rigging a standing derrick will serve as the confirmation of this TP.

---

#### Teaching Point 5

#### Have the Cadets, as Members of a Group, Operate a Standing Derrick

Time: 75 min

Method: Practical Activity



Demonstrate how to operate the standing derrick prior to starting the activity.

---

#### ACTIVITY

---

#### OBJECTIVE

The objective of this activity is to have the cadets, as members of a group, operate a standing derrick.

#### RESOURCES



The list of required equipment for a standing derrick is located in A-CR-CCP-603/PG-001, Chapter 2, Annex C, Appendix 1.

When choosing the equipment for rigging the standing derrick, ensure that each item is compatible with the others (e.g., the blocks are suitable for the size of the line).

- Assembled standing derrick,
- Load of 22 kg (50 lbs) or less,
- Whipping twine,
- Pylons,
- Hooks,
- Hard hats,

- Parts cards located at Annex E,
- Picture/model of a standing derrick (blank picture located at Annex F if required),
- Sequence for Station 3 located at Annex G,
- Scoresheet located at Annex H,
- Whistle, and
- Stopwatch.

### ACTIVITY LAYOUT

- Mark off a start line and set up personal safety equipment.
- Set up Station 1 with whipping twine and hooks.
- Set up Station 2 with the picture/model of the standing derrick and a bag/box with parts cards.
- Set up Station 3 with a standing derrick, whipping twine and a load.



The standing derrick in Station 3 shall be fully rigged (as illustrated in Figure 12-3-2).

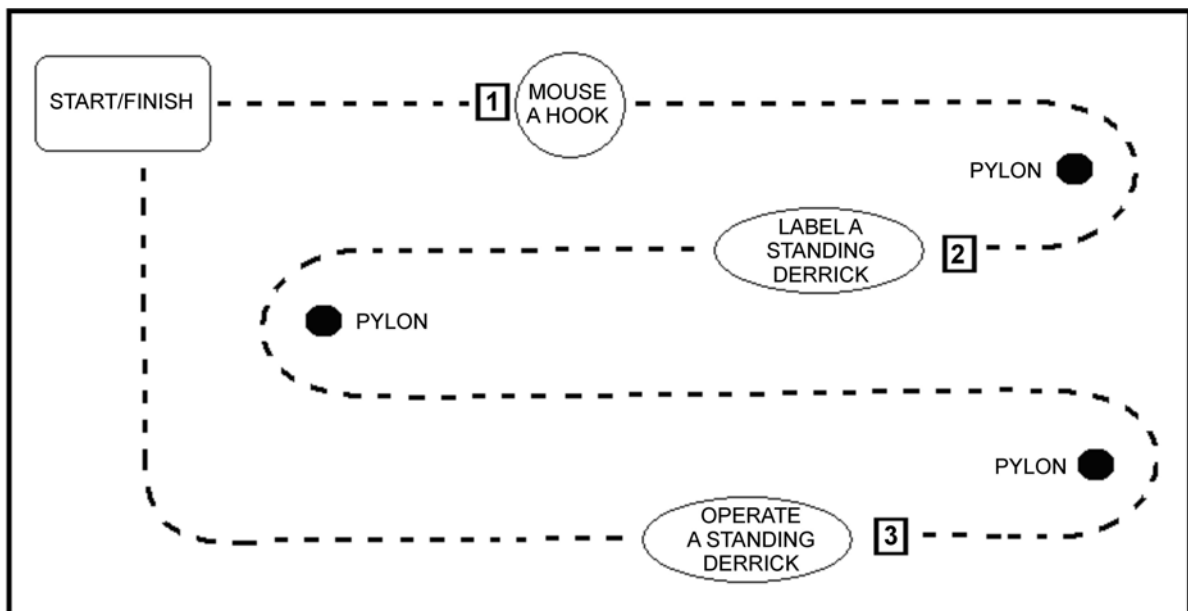

*Director Cadets 3, 2008, Ottawa, ON: Department of National Defence*

Figure 12-3-9 Standing Derrick Run

### ACTIVITY INSTRUCTIONS



Encourage the cadets to cheer on the groups while the activity is conducted.

1. Divide the cadets into groups of four.
2. Have the first group line up behind the start line.
3. On the whistle signal, have the group put on their personal safety equipment and proceed to Station 1.



Ensure the time is started on the stopwatch at the whistle signal.

4. At Station 1, have each cadet in the group mouse a hook. Check the mousings for strength. If any of the mousings come off easily, that cadet will do another mousing. Upon successfully completing the mousings, have the group proceed to Station 3.
5. At Station 2, have the group label the picture/model of the standing derrick and then proceed to Station 3.
6. At Station 3, stop and record the time. Have the group operate the standing derrick by responding to commands from Annex G given by the instructor. Award points IAW the scoresheet found at Annex H.
7. Upon completion of Station 3, have the group proceed to the finish line and tally the score.
8. Repeat the activity for the remaining groups.
9. Declare the group with the most points the winner.

#### **SAFETY**

- Ensure the personal safety equipment is worn at all times.
- Ensure the cadets stay clear of all danger zones when the standing derrick has been raised.
- Ensure all hooks are moused or fitted with working safety catches.

---

#### **CONFIRMATION OF TEACHING POINT 5**

---

The cadets' participation in the activity will serve as the confirmation of this TP.

---

#### **Teaching Point 6**

**Demonstrate and Have the Cadets, as Members of a Group, De-Rig a Standing Derrick**

Time: 10 min

Method: Demonstration and Performance

---

#### **DE-RIG A STANDING DERRICK**



Demonstrate and have the cadets practice each step in de-rigging the standing derrick.

1. Check away the topping lift handsomely, until the spar is resting on the ground.
2. Release the choke on the heel tackles, being careful not to place hands in between the running parts of the luff.



Once the spar is on the ground and the tension has been released from the heel tackles, the standing derrick is safe to de-rig.

3. Cut any mousings that have been applied and unhook the blocks from the strops.
4. Un-reeve the heel, guy, main purchase and topping lift tackles.
5. Remove the strops from the spar.
6. Remove the spar from the shoe.
7. Coil all lines and secure the equipment, as required.

---

### CONFIRMATION OF TEACHING POINT 6

---

The cadets de-rigging a standing derrick will serve as the confirmation of this TP.

---

### END OF LESSON CONFIRMATION

---

The cadets' rigging, operating and de-rigging a standing derrick will serve as the confirmation of this lesson.

---

### CONCLUSION

---

#### HOMEWORK/READING/PRACTICE

N/A.

#### METHOD OF EVALUATION

N/A.

#### CLOSING STATEMENT

Rigging a standing derrick is an exercise that requires teamwork. The standing derrick is a device that has many practical uses within the Canadian Navy, although it is not used as frequently today as in years past due to the development of technology. It acts as an introduction to sea activities of the Canadian Navy while stimulating an interest in seamanship specialty training.

#### INSTRUCTOR NOTES/REMARKS

This EO should be conducted after EO M321.01 (Describe Safety Procedures for Operating Lifting Devices, Section 1).

The cadets must wear issued cadet boots and hard hats while operating the standing derrick.

---

### REFERENCES

---

- A1-004 B-GN-181-105/FP-E00 Chief of the Maritime Staff. (2000). *CFCD 105 Fleet Seamanship Rigging and Procedures Manual*. Ottawa, ON: Department of National Defence.
- C1-047 (ISBN 0-11-772695-8/BON-050-002/PT-004) Command of the Defence Council. (1995). *BR 67 Admiralty Manual of Seamanship*. London, England: Her Majesty's Stationary Office Publications Centre.

C1-049 (ISBN 0-11-771958-7) Royal Navy. (1967). *Admiralty Manual of Seamanship 1967* (Vol. 2).  
Cambridge, England: Her Majesty's Stationery Office.





## ROYAL CANADIAN SEA CADETS

### PHASE THREE

### INSTRUCTIONAL GUIDE



### SECTION 4

### EO C321.03 – RIG A GYN

---

Total Time: 150 min

---



---

### PREPARATION

---

#### PRE-LESSON INSTRUCTIONS

Resources needed for the delivery of this lesson are listed in the lesson specification located in A-CR-CCP-603/PG-001, Chapter 4. Specific uses for said resources are identified throughout the instructional guide within the TP for which they are required.

Review the lesson content and become familiar with the material prior to delivering the lesson.

Photocopy and cut out the parts cards located at Annex I.

Photocopy the blank gyn diagram located at Annex J, the sequence for Station 3 located at Annex K and the gyn scoresheet located at Annex L.

Ensure that the cadets have their issued cadet boots with them.

#### PRE-LESSON ASSIGNMENT

N/A.

#### APPROACH

An interactive lecture was chosen for TPs 1–3 to illustrate the function, parts and rigging commands for a gyn.

Demonstration and performance was chosen for TPs 4 and 6 as it provides the instructor the opportunity to introduce a gyn, demonstrate procedures and observe the cadets rigging and de-rigging a gyn.

A practical activity was chosen for TP 5 as it is an interactive way to introduce the cadets to operating a gyn in a safe and controlled environment. This activity contributes to the development of seamanship skills and knowledge in a fun and challenging setting.

---

### INTRODUCTION

---

#### REVIEW

Review safe practices, personal safety equipment and gyn danger zones from EO M321.01 (Describe Safety Procedures for Operating Lifting Devices, Section 1).

#### OBJECTIVES

By the end of this lesson the cadet, as a member of a group, shall have rigged, operated and de-rigged a gyn.

## IMPORTANCE

It is important for cadets to rig a gyn as it introduces them to sea activities of the Canadian Forces while stimulating an interest in seamanship specialty training. Although the gyn is no longer used regularly by the Canadian Navy, it is a great way to foster teamwork and practice seamanship skills.

---

### Teaching Point 1

### Explain the Function of a Gyn

Time: 5 min

Method: Interactive Lecture

---

## GYN

Due to improvements in technology, improvised lifting devices are not as widely used today as in the past. However, when no suitable crane or hydraulic device is available on board or ashore for lifting a heavy object or equipment, some form of an improvised lifting device must be rigged. This may include, sheers, a standing or swinging derrick, or a gyn.

A gyn is the strongest of these types of improvised lifting devices and requires no additional rigging to support it. It is used for straight lifts only.

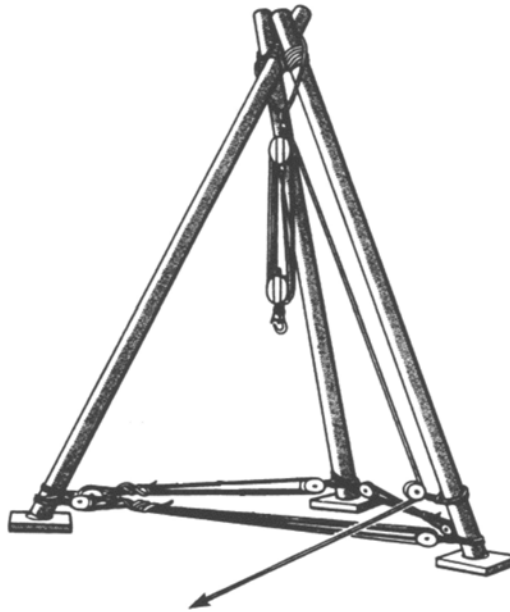

*Royal Navy, Admiralty Manual of Seamanship 1967 (Vol. 2), Her Majesty's Stationery Office (p. 198)*

Figure 12-4-1 Assembled Gyn

---

## CONFIRMATION OF TEACHING POINT 1

---

## QUESTIONS

- Q1. What is the strongest type of improvised lifting device?
- Q2. When is a gyn used?
- Q3. For what type of lift is a gyn used?

**ANTICIPATED ANSWERS**

- A1. Gyn.
- A2. When no suitable crane or hydraulic device is available on board or ashore for lifting a heavy object or equipment.
- A3. Straight lifts.

**Teaching Point 2****Identify the Parts of a Gyn**

Time: 15 min

Method: Interactive Lecture

**PARTS OF A GYN**

**Head Lashing.** The head lashing forms the head of the gyn. The spars are lashed together to form a tripod using six to eight figure-of-eight turns.

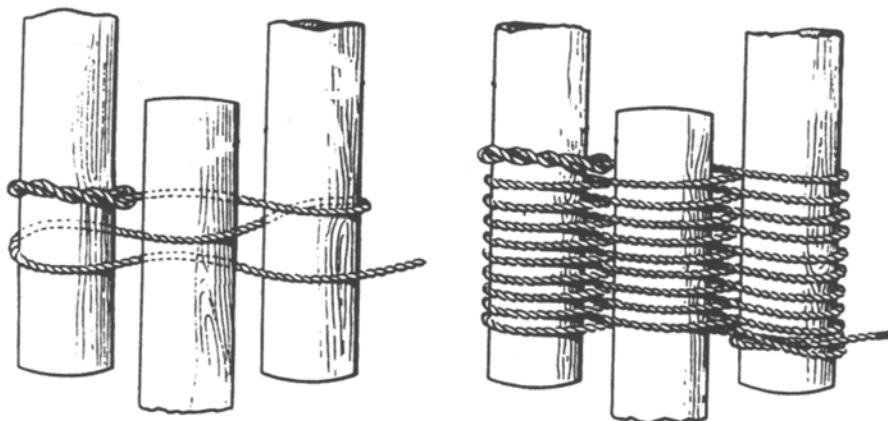

*Royal Navy, Admiralty Manual of Seamanship 1967 (Vol. 2), Her Majesty's Stationery Office (p. 207)*

Figure 12-4-2 Head Lashing

**Spars.** Spars are the basis of the tripod, acting as the legs of the gyn. There are three spars used in the rigging of the gyn. The heads of the spars are lashed together with a head lashing to connect them. When applying the head lashing, the spars are laid out parallel with the centre spar – the prypole – in the opposite direction from the other spars – the cheeks.

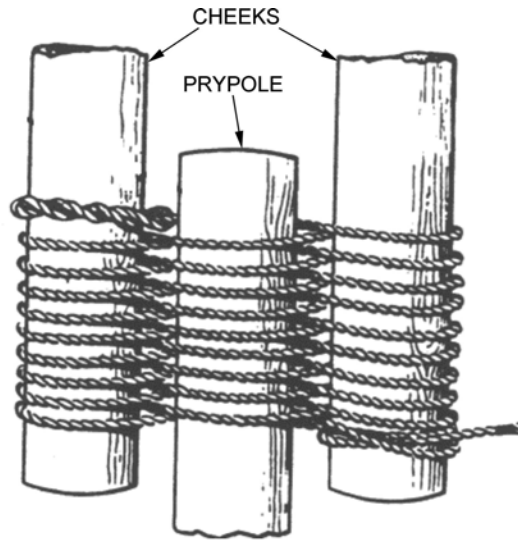

Royal Navy, Admiralty Manual of Seamanship 1967 (Vol. 2), Her Majesty's Stationery Office (p. 207)

Figure 12-4-3 Spars

**Main Purchase.** The main purchase, consisting of a two-fold purchase, is attached to the head of the spars and is used to lift the load (as illustrated in Figure 12-4-4).

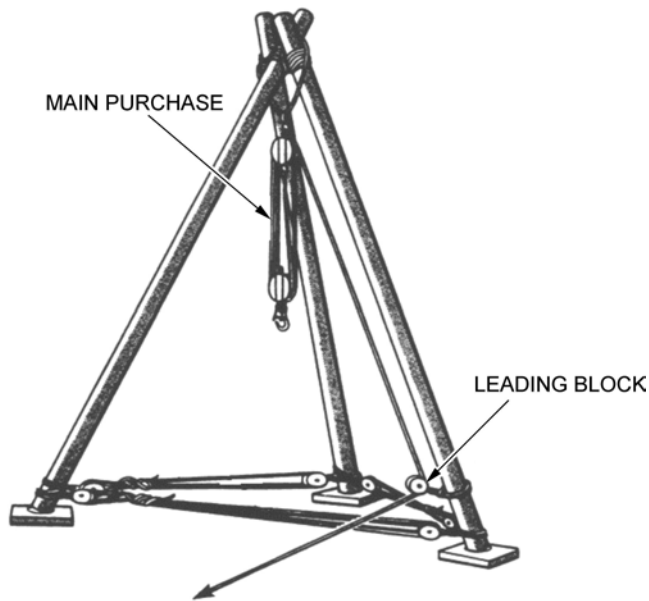

Royal Navy, Admiralty Manual of Seamanship 1967 (Vol. 2), Her Majesty's Stationery Office (p. 198)

Figure 12-4-4 Main Purchase and Shoes

**Strops.** Strops are a continuous loop in a line or wire rope. They are used to pass around a cask, spar, piece of line, etc to provide an eye to be placed over a hook or shackle (as illustrated in Figure 12-4-5).

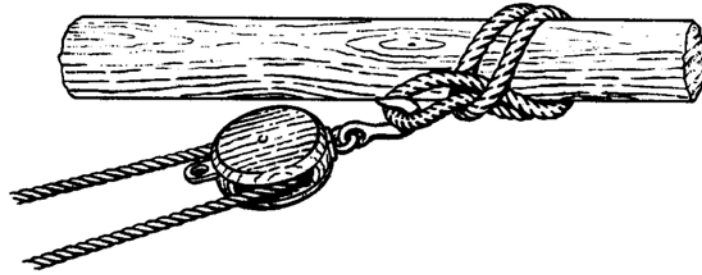

Royal Navy, Admiralty Manual of Seamanship 1964 (Vol. 1), Her Majesty's Stationery Office (p. 193)

Figure 12-4-5 Strop on a Spar

**Leading Block (for the Fall of the Main Purchase).** The leading block is secured to one of the spars and the hauling part, or fall of the main purchase is led through it (as illustrated in Figure 12-4-4). This block is used to change the direction of pull on the fall.



The fall of the main purchase refers to its hauling part which exits the standing block attached to the head of the gyn. The fall must be heaved in, in a downward motion, directly under the spars. The leading block allows the line to be safely heaved in from the side of the gyn.

**Splay Tackles.** The splay tackles, consisting of luffs, are rigged between each leg to prevent the legs from splaying – moving further apart – when they are under load.

**Shoes (if Fitted).** Shoes are usually square slabs of hardwood with a recess in their upper surfaces to take the heels of the spars (as illustrated in Figure 12-4-6). The length of each side should not be less than four times the diameter of the spar. They are used to distribute the weight of the load and the thrust of the spar over an area of the deck. When ashore, they are used to distribute the weight so as to prevent the spar from sinking into the ground.

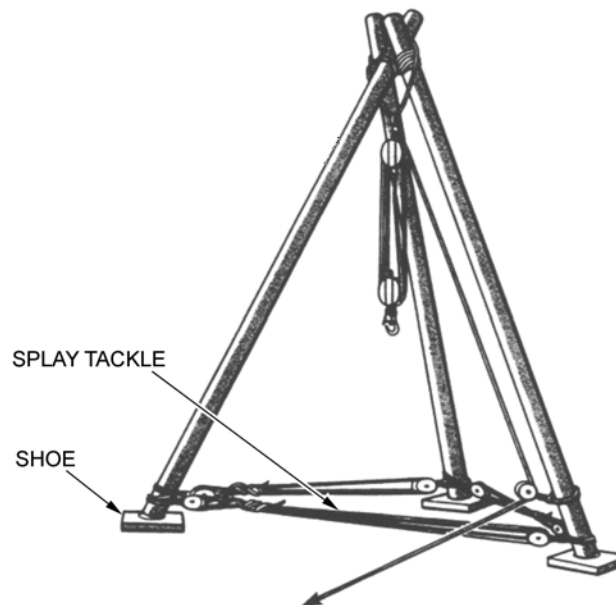

Royal Navy, Admiralty Manual of Seamanship 1967 (Vol. 2), Her Majesty's Stationery Office (p. 198)

Figure 12-4-6 Splay Tackles and Shoes

**Thumb Pieces/Rope Collars (if Fitted).** Thumb pieces/rope collars are used to prevent the strops from slipping on the spars. Thumb pieces are wooden pieces that are screwed or nailed onto the spar. Rope collars are put onto the spar like a whipping.

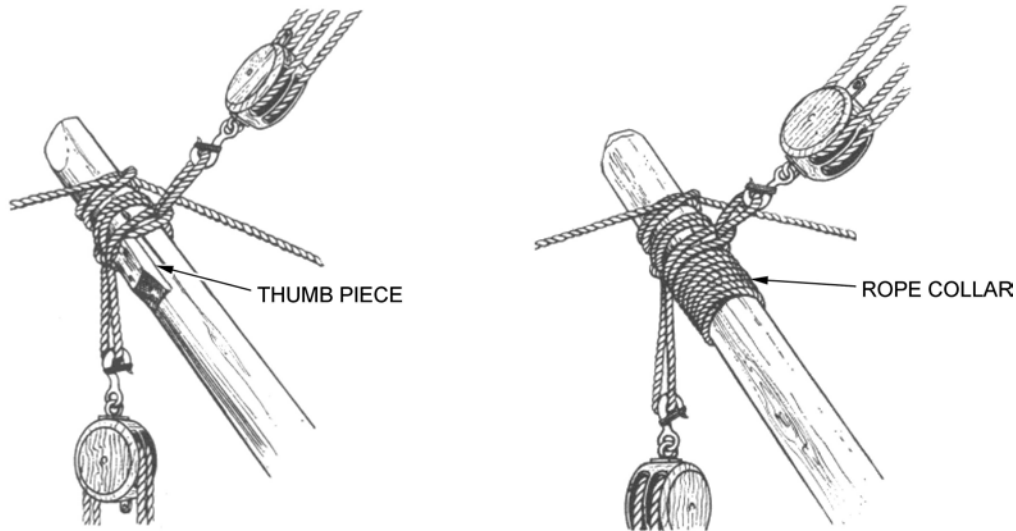

*Royal Navy, Admiralty Manual of Seamanship 1967 (Vol. 2), Her Majesty's Stationery Office (p. 207)*

Figure 12-4-7 Thumb piece and Rope Collar

---

## CONFIRMATION OF TEACHING POINT 2

---

### QUESTIONS

- Q1. What are splay tackles used for?  
 Q2. What is the centre spar called?  
 Q3. What are thumb pieces/rope collars used for?

### ANTICIPATED ANSWERS

- A1. To prevent the legs from splaying – moving further apart – when they are under load.  
 A2. Prypole.  
 A3. To prevent the strops from slipping on the spars.

---

### Teaching Point 3

### Describe the Actions Taken in Response to Commands

Time: 15 min

Method: Interactive Lecture

---

**Heave in.** Give a strong pull together on a line.

**Check Away.** Ease out a line under control.

**Avast.** Stop.

**Choke.** Choke the standing block with the hauling part and secure it with two half hitches above the crown.

**Secure.** Make fast a line.

**Handsomely.** Slowly, carefully.

**Roundly.** Rapidly.

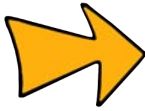

These are the most commonly used commands for working with the gyn. However, the list is not exhaustive. Other commands may be used based on unit preferences.

---

### CONFIRMATION OF TEACHING POINT 3

---

#### QUESTIONS

- Q1. What does the order HEAVE IN mean?  
 Q2. What order is given to make fast a line?  
 Q3. What does the order AVAST mean?

#### ANTICIPATED ANSWERS

- A1. Give a strong pull together on a line.  
 A2. SECURE.  
 A3. Stop.

---

#### Teaching Point 4

**Demonstrate and Have the Cadets, as Members of a Group, Rig a Gyn**

Time: 20 min

Method: Demonstration and Performance

---

#### RIGGING A GYN



Demonstrate and have the cadets practice each step in rigging the gyn.

1. Mark the position for the head lashing on the three spars to be used for legs. Lay the spars parallel to each other, five centimetres (two inches) apart, with the heel of the centre spar – the prypole – pointing in the opposite direction from the other two spars – the cheeks (as illustrated in Figure 12-4-8).

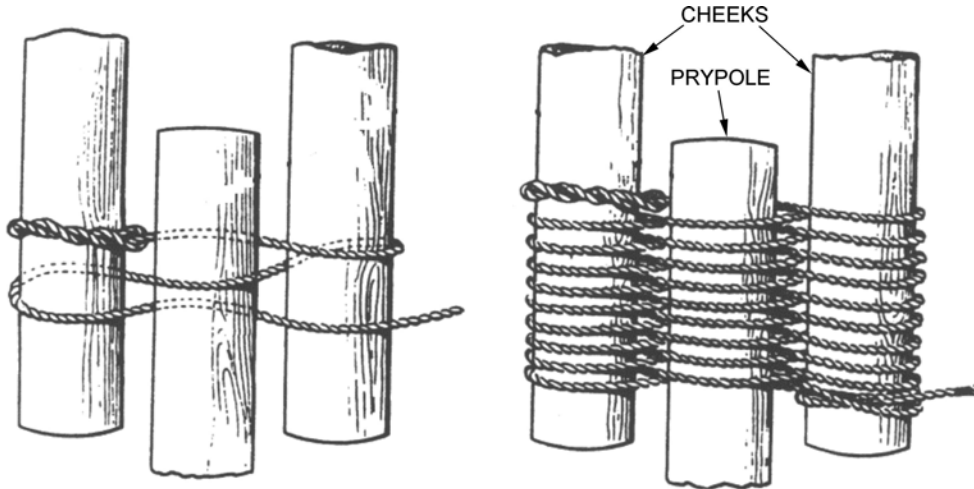

*Royal Navy, Admiralty Manual of Seamanship 1967 (Vol. 2), Her Majesty's Stationery Office (p. 207)*

Figure 12-4-8 Head Lashing

2. Support the heads of the spars above the deck. Start the head lashing with a timber hitch on one of the cheeks followed by six to eight figure-of-eight turns around the spars and finish with a clove hitch around the opposite cheek (as illustrated in Figure 12-4-9). Apply the lashing loose enough to allow the gyn to be raised but no so loose that it will slip once the gyn is erect.



An alternative approach to applying the head lashing is to place the three spars parallel with the heel of the prypole even with the heads of the cheeks. This allows the figure-of-eight turns to be applied easily over the ends. Once all turns are in place, the prypole is then slid back through the turns until the heads are positioned together (as illustrated in Figure 12-4-8).

3. Place a rope collar around the prypole to prevent the head lashing from slipping down the spar when raising the gyn.
4. Place the main purchase strop around the head lashing (as illustrated in Figure 12-4-9). The strop goes under the head lashing and over the tip of the prypole. The bight on each side is slipped over the tips of the cheeks. Ensure that the splice is positioned so that it will not come in contact with the hook of the block once the gyn is raised.





*Navy League of Canada, NLP 101 Flotilla and Provincial Seamanship Competition Manual, Navy League of Canada (p. 12)*

Figure 12-4-9 Head Lashing Stop

- Rig the main purchase using a two-fold purchase (as illustrated in Figure 12-4-10). Attach the standing block to the main purchase strop (as illustrated in Figure 12-4-9). Ensure that the main purchase is rigged to disadvantage with the hauling part exiting the standing block.

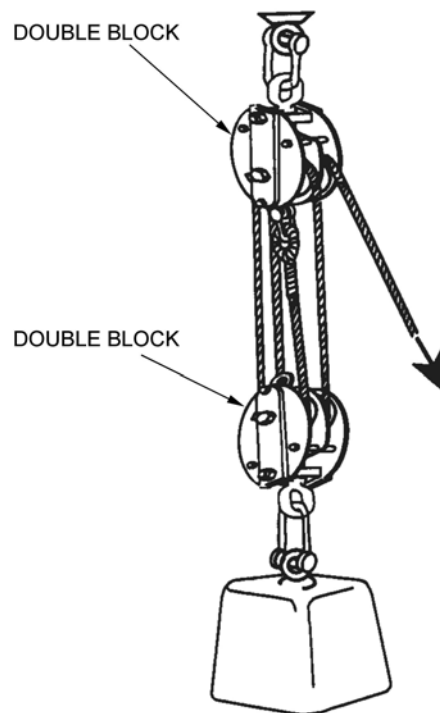

*BON-050-002/PT-004 (p. 3-155)*

Figure 12-4-10 Two-Fold Purchase

- Place the splay tackle strops and the leading block strop at the feet of the spars (as illustrated in Figure 12-4-11).



The strop for the leading block may be attached above or between the splay tackle strops.

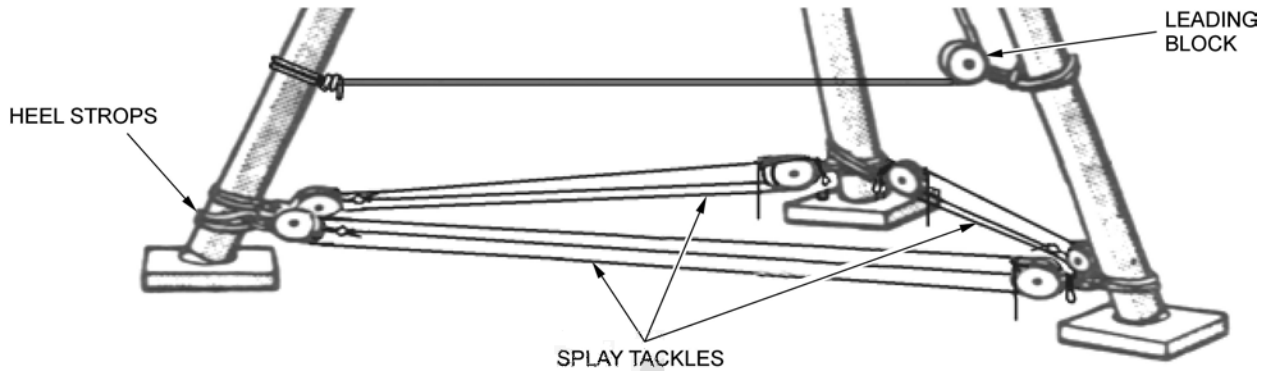

Royal Navy, Admiralty Manual of Seamanship 1964 (Vol. 1), Her Majesty's Stationery Office (p. 193)

Figure 12-4-11 Gyn Splay Tackles

7. Rig the splay tackles using luffs (as illustrated in Figure 12-4-12) and attach to the strops between the spars. Tie figure eight knots in the ends of the hauling parts.

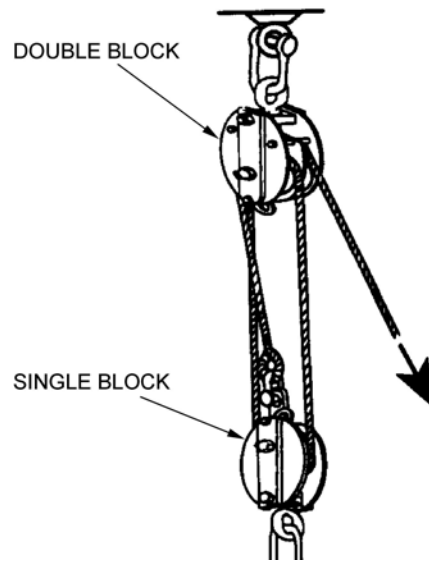

BON-050-002/PT-004 (p. 3-155)

Figure 12-4-12 Luff

8. Attach the leading block to the leading block stop and lead the fall of the main purchase through it. Tie a figure eight knot in the end of the fall.
9. Place thumb pieces/rope collars on the heels of the spars above the strops to prevent the strops from slipping up the spars.
10. Mouse all hooks (as illustrated in Figure 12-4-13).

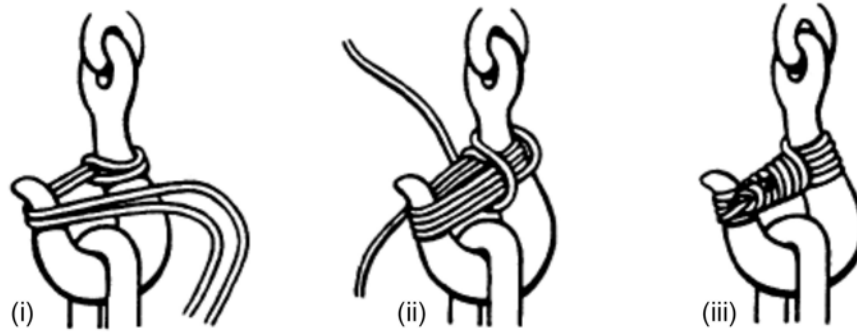

B-GN-181-105/FP-E00 (p. 5-46)

Figure 12-4-13 Mousing a Hook



Mousing is not required for blocks equipped with a safety catch on the hook. If the safety catch has been removed or the spring is missing from the catch, the block must be replaced.

11. Raise the head of the gyn to chest height. Heave in the splay tackles to pull the heels together. Continue heaving in handsomely until the distance between the heels of the gyn are approximately one-third the length of the spars used for the gyn. Choke and secure the splay tackles. Coil any excess line on the deck beside the spars.



Extreme care should be exercised here as the gyn may topple over if the splay tackles are not heaved in evenly. It is advisable to heave in splay tackles individually once the gyn nears its full height.

If the splay tackles do not heave in easily, ensure that the head lashing has not been applied too tightly.

12. The gyn is now complete and ready for operation (as illustrated in Figure 12-4-14).

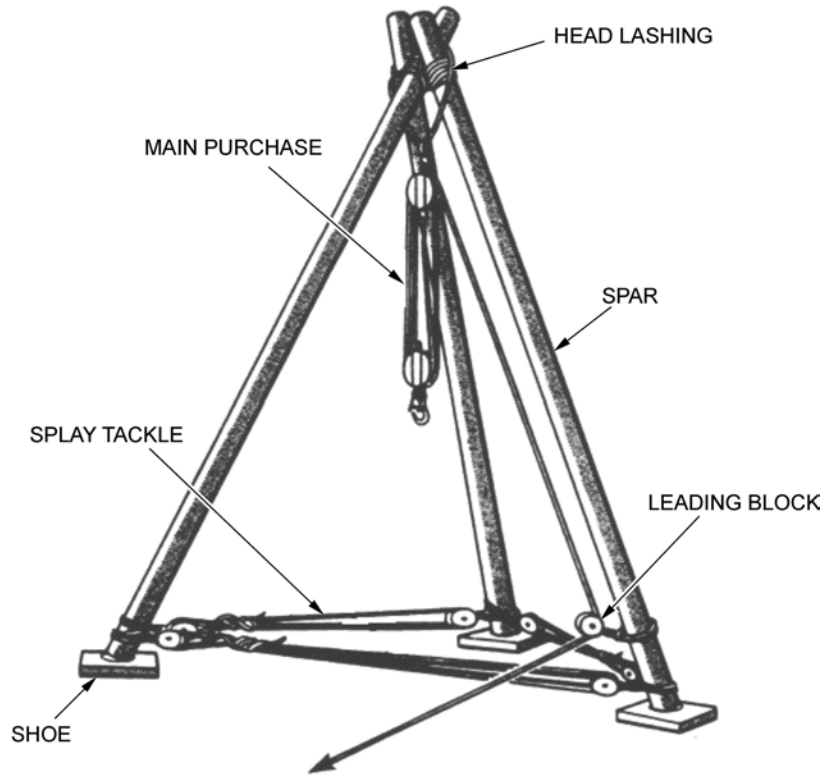

Royal Navy, Admiralty Manual of Seamanship 1967 (Vol. 2), Her Majesty's Stationery Office (p. 198)

Figure 12-4-14 Assembled Gyn

---

### CONFIRMATION OF TEACHING POINT 4

---

The cadets' participation in rigging the gyn will serve as the confirmation of this TP.

---

#### Teaching Point 5

**Demonstrate and Have the Cadets, as Members of a Group, Operate a Gyn**

Time: 75 min

Method: Practical Activity

---



Demonstrate how to operate the gyn prior to starting the activity.

---

### ACTIVITY

---

#### OBJECTIVE

The objective of this activity is to have the cadets, as members of a group, operate a gyn.

## RESOURCES



The list of required equipment for a gyn is located in A-CR-CCP-603/PG-001, Chapter 2, Annex C, Appendix 1.

When choosing the equipment for rigging the gyn, ensure that each item is compatible with the others (e.g., the blocks are suitable for the size of the line).

- Assembled gyn,
- Load of 22 kg (50 lbs) or less,
- Whipping twine,
- Pylons,
- Hooks,
- Hard hats,
- Parts cards located at Annex I,
- Picture/model of a gyn (blank picture located at Annex J, if required),
- Sequence for station 3 located at Annex K,
- Gyn scoresheet located at Annex L,
- Whistle, and
- Stopwatch.

## ACTIVITY LAYOUT

- Mark off a start area.
- Set up Station 1 with whipping twine and hooks.
- Set up Station 2 with parts cards, tape and a picture/model of a gyn.
- Set up Station 3 with a gyn, whipping twine and a load.



The gyn in Station 3 shall be fully rigged (as illustrated in Figure 12-4-14).

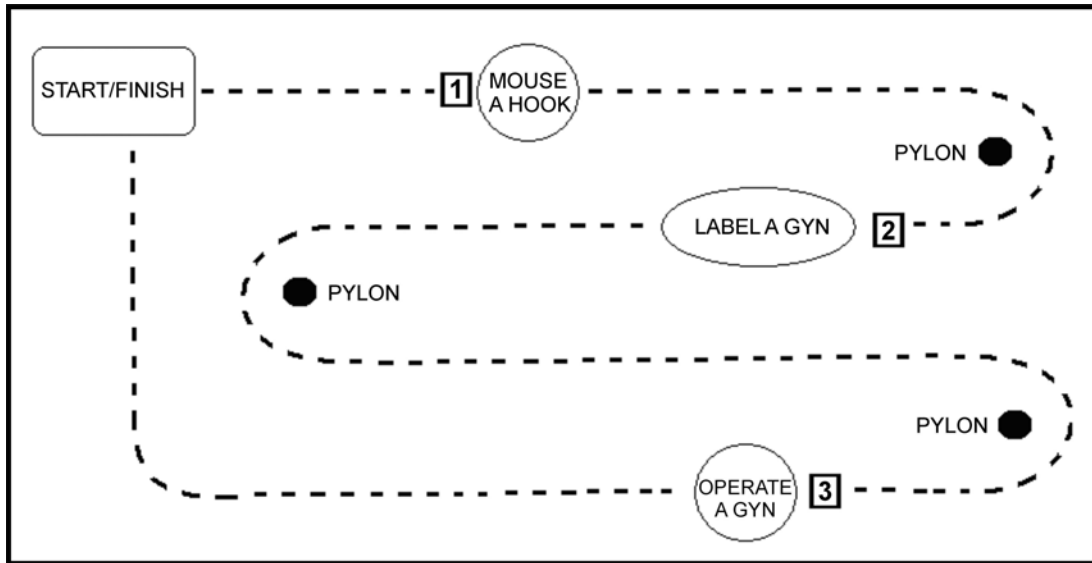

*Director Cadets 3, 2007, Ottawa, ON: Department of National Defence*

Figure 12-4-15 Gyn Run

### ACTIVITY INSTRUCTIONS

1. Divide the cadets into groups of three.
2. Have the first group line up in the start area.
3. On the whistle signal, the group is to put on their personal safety equipment and proceed to Station 1.



Ensure the time is started on the stopwatch at the whistle signal.

4. At Station 1, have each cadet in the group mouse a hook. Check the mousings for strength. If any of the mousings come off easily, that cadet will do another mousing. Upon successfully completing the mousings, have the group proceed to Station 2.
5. At Station 2, have the group label the picture/model of the gyn and then proceed to Station 3.
6. At Station 3, stop and record the time. Have the group operate the gyn by responding to commands from Annex K as given by the instructor. Award points IAW the scoresheet found at Annex L.
7. Upon completion of Station 3, have the group continue to the finish line and tally the score.
8. Have each group complete the gyn run in the above sequence.
9. Declare the group with the most points the winner.

### SAFETY

- Ensure the personal safety equipment is worn at all times.
- Ensure the cadets stay clear of the load while it is in motion.
- Ensure all hooks are moused or fitted with working safety catches.

---

### CONFIRMATION OF TEACHING POINT 5

---

The cadets' participation in the activity will serve as the confirmation of this TP.

---

#### Teaching Point 6

#### Demonstrate and Have the Cadets, as Members of a Group, De-Rig a Gyn

Time: 10 min

Method: Demonstration and Performance

---

#### DE-RIG A GYN



Demonstrate and have the cadets practice each step in de-rigging the gyn.

1. Release the choke on the splay tackles, being careful not to place hands between the standing parts of the luff.
2. Check away on the splay tackles handsomely as the heels are pulled out to lower the gyn. To ensure that the gyn is lowered safely, have one cadet check away on the splay tackle and another cadet pull out each spar by hand.
3. Once the head of the gyn is at chest height, it may be lowered by hand until it is resting on the deck.



The gyn is safe to de-rig once the head is resting on the ground.

4. Cut any mousings that have been applied and unhook the blocks from the strops.
  5. Un-reeve the splay tackles and main purchase.
  6. Remove the strops from the spars.
  7. Remove the head lashing from the spars.
  8. Coil all lines and secure the equipment as required.
- 

### CONFIRMATION OF TEACHING POINT 6

---

The cadets' participation in de-rigging a gyn will serve as the confirmation of this TP.

---

### END OF LESSON CONFIRMATION

---

The cadets' rigging, operating and de-rigging a gyn will serve as the confirmation of this lesson.

---

### CONCLUSION

---

#### HOMework/READING/PRACTICE

N/A.

## METHOD OF EVALUATION

N/A.

## CLOSING STATEMENT

The operation of a gyn is an exercise that requires teamwork. It is a device that has many practical uses within the Canadian Navy, although it is not used as frequently today as in years past due to improvements in technology. The gyn acts as an introduction to sea activities of the Canadian Forces while stimulating an interest in seamanship specialty training.

## INSTRUCTOR NOTES/REMARKS

This EO shall be conducted after EO M321.01 (Describe Safety Procedures for Operating Lifting Devices, Section 1).

The cadets must wear issued cadet boots and hard hats while operating the gyn.

---

## REFERENCES

---

- A1-004 B-GN-181-105/FP-E00 Chief of the Maritime Staff. (2000). *CFCD 105 Fleet Seamanship Rigging and Procedures Manual*. Ottawa, ON: Department of National Defence.
- C1-003 (ISBN 11-770973-5) Royal Navy. (1972). *Admiralty Manual of Seamanship* (Vol. 1). London, England: Her Majesty's Stationery Office.
- C1-047 (ISBN 0-11-772695-8/BON-050-002/PT-004) Command of the Defence Council. (1995). *BR 67 Admiralty Manual of Seamanship*. London, England: Her Majesty's Stationery Office Publications Centre.
- C1-049 (ISBN 0-11-771958-7) Royal Navy. (1967). *Admiralty Manual of Seamanship 1964* (Vol. 2). Cambridge, England: Her Majesty's Stationery Office.





## ROYAL CANADIAN SEA CADETS

### PHASE THREE

### INSTRUCTIONAL GUIDE



### SECTION 5

### EO C321.04 – MAKE A MONKEY'S FIST

Total Time:

60 min

### PREPARATION

#### PRE-LESSON INSTRUCTIONS

Resources needed for the delivery of this lesson are listed in the lesson specification located in A-CR-CCP-603/PG-001, Chapter 4. Specific uses for said resources are identified throughout the instructional guide within the TP for which they are required.

Review the lesson content and become familiar with the material prior to delivering the lesson.

Complete a monkey's fist to be used as a model for the lesson.

Photocopy the monkey's fist pattern located at Annex N for each cadet if the alternative method will be taught.

#### PRE-LESSON ASSIGNMENT

N/A.

#### APPROACH

An interactive lecture was chosen for TP 1 to explain the use of the monkey's fist.

Demonstration and performance was chosen for TP 2 as it allows the instructor to demonstrate making a monkey's fist while providing an opportunity for the cadets to practice this skill under supervision.

### INTRODUCTION

#### REVIEW

N/A.

#### OBJECTIVES

By the end of this lesson the cadet shall have made a monkey's fist.

#### IMPORTANCE

It is important for cadets to know how to make a monkey's fist as it introduces advanced ropework skills in a fun and challenging way, while providing a practical skill that can be used in today's maritime community.

**Teaching Point 1****Explain the Use of a Monkey's Fist**

Time: 5 min

Method: Interactive Lecture

**USE OF A MONKEY'S FIST**

To get heavy lines from the ship to the shore or ship to ship, a light line known as a heaving line, is used to pull the heavier line across. To give weight to the end of the heaving line, a monkey's fist is often used.

When this knot is made, a small, round cork or wooden ball can be placed inside the knot prior to completion. Care should be taken that the finished knot is not so heavy as to be dangerous to the people ashore.

Sea cadets today will see this knot used on heaving lines as well as for many decorative uses such as finishing the ends of guide ropes and key fobs.

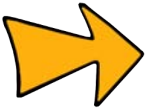

The monkey's fist has a special significance to a sailor because it is often the first thing that connects them with the land at the end of a voyage.

**CONFIRMATION OF TEACHING POINT 1****QUESTIONS**

- Q1. Why is the monkey's fist used?  
 Q2. What can be placed inside the monkey's fist?  
 Q3. Where can the monkey's fist be used decoratively?

**ANTICIPATED ANSWERS**

- A1. To give weight to the end of a heaving line.  
 A2. A small round cork or wooden ball.  
 A3. At the end of a guide rope or key fob.

**Teaching Point 2****Demonstrate and Have the Cadets Make a Monkey's Fist**

Time: 45 min

Method: Demonstration and Performance

**STEPS FOR MAKING A MONKEY'S FIST**

Demonstrate and have the cadets practice each step in making the monkey's fist.

To introduce cadets to the use of a knot-weaving board, an alternative method for making a monkey's fist is located at Annex M. This method introduces the cadets to knot-weaving used for more ornamental ropework.

1. Wind three turns around the hand (as illustrated in Figure 12-5-1).



*B-GN-181-105/FP-E00 (p. 5-35)*

Figure 12-5-1 Monkey's Fist Step 1

2. Pinch the turns together and pass a second set of three turns across and around the first three (as illustrated in Figure 12-5-2).



*B-GN-181-105/FP-E00 (p. 5-35)*

Figure 12-5-2 Monkey's Fist Step 2

3. Pass a third set of three turns around and across the second set but inside the first set, in the direction shown by the arrows (as illustrated in Figure 12-5-3).



If the knot is correctly made, the end will come out alongside the standing part.

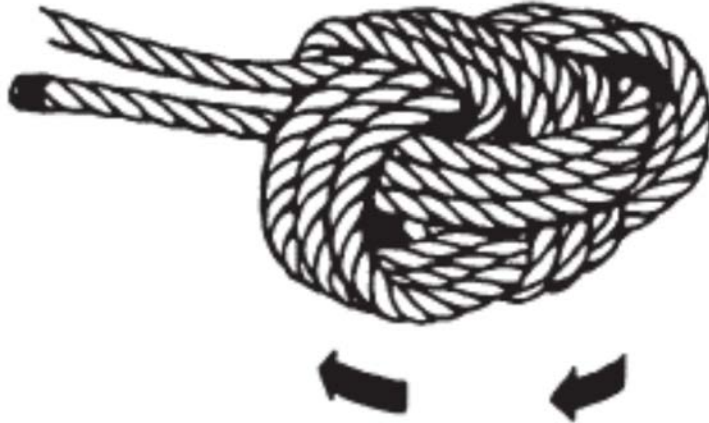

*B-GN-181-105/FP-E00 (p. 5-35)*

Figure 12-5-3 Monkey's Fist Step 3



If required, insert a small, round cork or wooden ball into the centre of the knot before pulling the parts taut.

- Carefully pull each part taut in the opposite direction from which it was tied until it becomes snug. The knot should be rolled around in a circular motion with the palms of the hands to even out the shape.
- Use a fid or something pointed to pick and pull each cord to an even firmness.

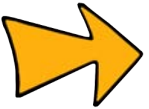

When the last parts of the cord are tensioned, there is a tendency for the loose loop of cord to twist as it passes through the tightened sections. To prevent this twisting, maintain tension on the loop in one hand as the cord is drawn through, until it can no longer be easily grasped. The short loop should tuck in with little or no twist in it.

- To finish the knot, seize the bitter end to the standing part where it comes out of the monkey's fist.



*B-GN-181-105/FP-E00 (p. 5-35)*

Figure 12-5-4 Completed Monkey's Fist



Tucking the bitter end inside the monkey's fist, then working all parts taut is another method of finishing off the knot.

---

### CONFIRMATION OF TEACHING POINT 2

---

The cadets' completion of a monkey's fist will serve as the confirmation of this TP.

---

### END OF LESSON CONFIRMATION

---

The cadets' completion of a monkey's fist will serve as the confirmation of this lesson.

---

### CONCLUSION

---

#### HOMEWORK/READING/PRACTICE

N/A.

#### METHOD OF EVALUATION

N/A.

#### CLOSING STATEMENT

Making a monkey's fist provides a way of introducing advanced ropework skills in a fun and challenging way. A monkey's fist is used commonly for heaving lines in today's maritime community.

#### INSTRUCTOR NOTES/REMARKS

N/A.

---

### REFERENCES

---

- A1-004 B-GN-181-105/FP-E00 Chief of the Maritime Staff. (2000). *CFCD 105 Seamanship Rigging and Procedures Manual*. Ottawa, ON: Department of National Defence.
- C1-102 Fukuhara, D. (2002). *Fancy Knotting: An Introduction*. Vancouver, BC: David Fukuhara.

THIS PAGE INTENTIONALLY LEFT BLANK



**ROYAL CANADIAN SEA CADETS**  
**PHASE THREE**  
**INSTRUCTIONAL GUIDE**



**SECTION 6**  
**EO C321.05 – MAKE A TURK’S HEAD**

---

Total Time: 60 min

---



---

**PREPARATION**

---

**PRE-LESSON INSTRUCTIONS**

Resources needed for the delivery of this lesson are listed in the lesson specification located in A-CR-CCP-603/PG-001, Chapter 4. Specific uses for said resources are identified throughout the instructional guide within the TP for which they are required.

Review the lesson content and become familiar with the material prior to delivering the lesson.

Make a turk’s head to be used as a model for the lesson.

Photocopy the turk’s head pattern located at Annex P for each cadet if the alternative method will be taught.

**PRE-LESSON ASSIGNMENT**

N/A.

**APPROACH**

An interactive lecture was chosen for TP 1 to explain the use of the turk’s head.

Demonstration and performance was chosen for TP 2 as it allows the instructor to demonstrate making a turk’s head while providing an opportunity for the cadets to practice this skill under supervision.

---

**INTRODUCTION**

---

**REVIEW**

N/A.

**OBJECTIVES**

By the end of this lesson the cadet shall have made a turk’s head.

**IMPORTANCE**

It is important for cadets to know how to make a turk’s head as it introduces advanced ropework skills in a fun and challenging way, while providing a practical skill that can be used in rigging lifting devices and in ornamental ropework.

---

**Teaching Point 1****Explain the Use of a Turk's Head**

Time: 5 min

Method: Interactive Lecture

---

**USE OF A TURK'S HEAD**

The turk's head is an ornamental knot that is supposed to resemble the turban once worn in Turkey. It may be made either as a standing or a running knot. A standing turk's head is made in the end of a line (as illustrated in Figure 12-6-1) and is used as an ornamental stopper knot. A running turk's head is made around a bight of rope, a stanchion or other fitting (as illustrated in Figure 12-6-2) using a single length of cord.

*B-GN-181-105/FP-E00 (p. 5-40)*

Figure 12-6-1 Standing Turk's Head

*B-GN-181-105/FP-E00 (p. 5-42)*

Figure 12-6-2 Running Turk's Head

In addition to its ornamental ropework uses, the running turk's head can be used on lifting devices as an alternative to a rope collar. When made taut around a pipe or hose, the turk's head will rival the holding strength of a metal clamp.

---

**CONFIRMATION OF TEACHING POINT 1**

---

**QUESTIONS**

- Q1. How did the turk's head get its name?
- Q2. In what forms can a turk's head be made?
- Q3. What can a running turk's head be used for?

**ANTICIPATED ANSWERS**

- A1. It is supposed to resemble the turban once worn in Turkey.
- A2. Standing and running.
- A3. Ornamental ropework, alternative to a rope collar, pipe or hose clamp.



**Teaching Point 2****Demonstrate and Have the Cadets Make a Turk's Head**

Time: 45 min

Method: Demonstration and Performance

**STEPS FOR MAKING A TURK'S HEAD**

Demonstrate and have the cadets practice the steps for making a turk's head.

To introduce cadets to the use of a knot-weaving cylinder, an alternative method for making a turk's head is located at Annex O. This method introduces the cadets to knot-weaving used for more ornamental ropework.

1. Make a half hitch around a rope or fitting followed by a round turn (as illustrated in Figure 12-6-3).
2. Dip the end under the bight of the half hitch (as illustrated in Figure 12-6-3).

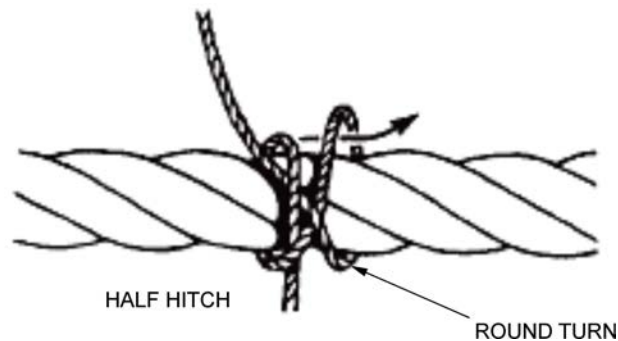

*B-GN-181-105/FP-E00 (p. 5-42)*

Figure 12-6-3 Steps 1–3

3. Cross the bight – that is on the same side as the lead end – underneath the other bight (as illustrated in Figure 12-6-3).
4. Pass the end down between the bights to the other side (as illustrated in Figure 12-6-4).



*B-GN-181-105/FP-E00 (p. 5-42)*

Figure 12-6-4 Step 4

5. Steps 3. and 4. are repeated until the rope is encircled (as illustrated in Figure 12-6-5).



B-GN-181-105/FP-E00 (p. 5-42)

Figure 12-6-5 Step 5

6. Follow the ends around as many times as required (as illustrated in Figure 12-6-6). Finish the knot by hauling all parts taut and trimming the ends off flush with the knot.



B-GN-181-105/FP-E00 (p. 5-42)

Figure 12-6-6 Step 6

---

**CONFIRMATION OF TEACHING POINT 2**

---

The cadets' making a turk's head will serve as the confirmation of this TP.

---

**END OF LESSON CONFIRMATION**

---

The cadets' making a turk's head will serve as the confirmation of this lesson.

---

**CONCLUSION**

---

**HOMEWORK/READING/PRACTICE**

N/A.

**METHOD OF EVALUATION**

N/A.

**CLOSING STATEMENT**

Making a turk's head introduces advanced ropework skills in a fun and challenging way. A turk's head is commonly used as a substitute for a rope collar and can also be used to decorate circular objects.

**INSTRUCTOR NOTES/REMARKS**

N/A.

---

**REFERENCES**

---

- A1-004 B-GN-181-105/FP-E00 Chief of the Maritime Staff. (2000). *CFCD 105 Seamanship Rigging and Procedures Manual*. Ottawa, ON: Department of National Defence.
- C1-102 Fukuhara, D. (2002). *Fancy Knotting: An Introduction*. Vancouver, BC: David Fukuhara.

THIS PAGE INTENTIONALLY LEFT BLANK

PARTS CARDS – SHEERS

SPLAY TACKLE	SHOE
STROP	HEAD LASHING
MAIN PURCHASE	LEADING BLOCK
SPAR	HEEL TACKLE
TOPPING LIFT	TAG LINE

THIS PAGE INTENTIONALLY LEFT BLANK

**ASSEMBLED SHEERS**

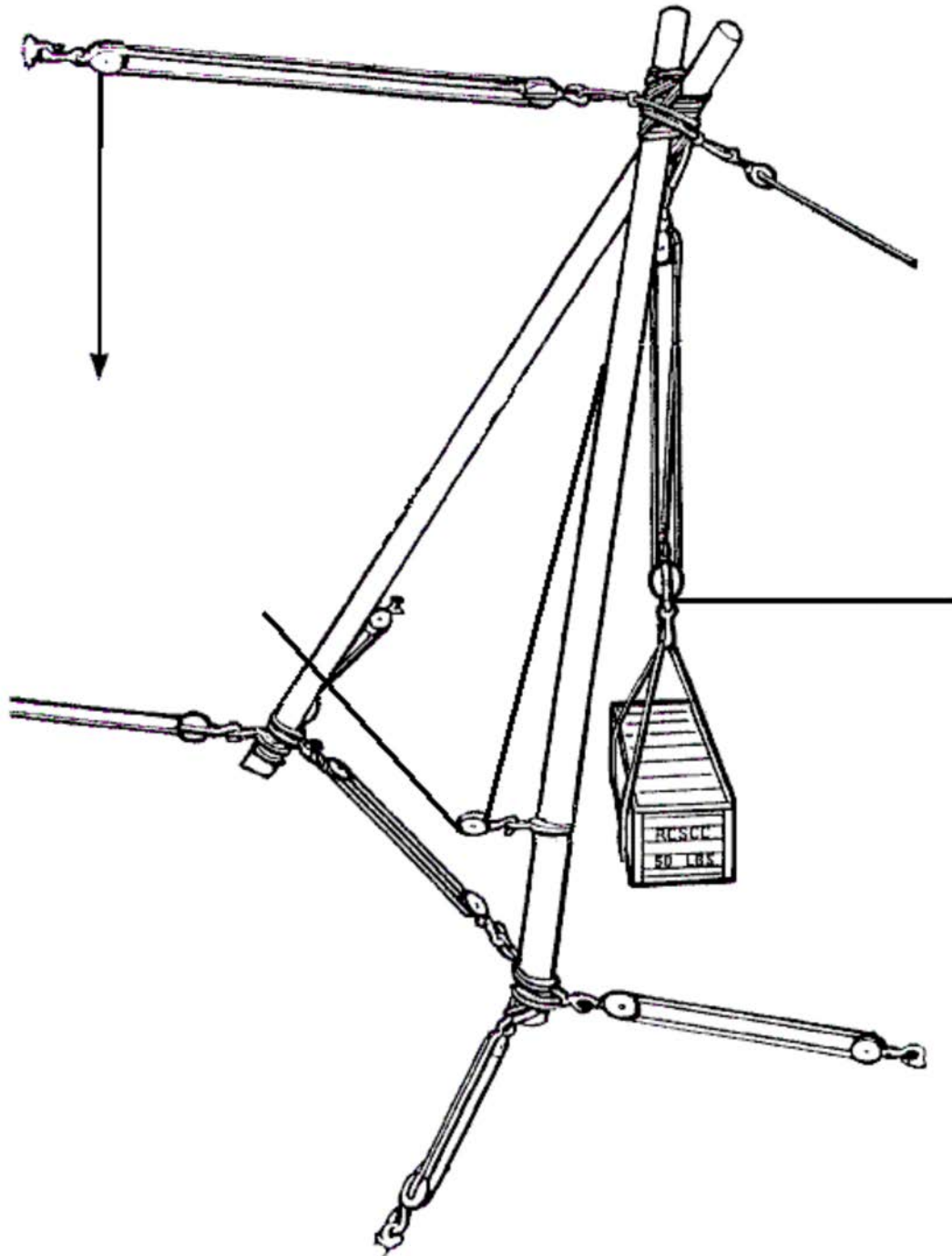

*Royal Navy, Admiralty Manual of Seamanship 1967 (Vol. 2), Her Majesty's Stationery Office (p. 197)*

Figure 12B-1 Assembled Sheers

THIS PAGE INTENTIONALLY LEFT BLANK



### SEQUENCE FOR STATION 3 – OPERATING THE SHEERS



The sheers will be fully rigged and lowered to an angle of 30 degrees from the ground with the tag line attached to the main purchase and extended out of the forward danger zone.

The following sequence will be followed by each group for Station 3:

1. hook on the load (hook must be moused) – five points; and
2. respond to the following commands – five points each:
  - (a) heave in main purchase;
  - (b) avast;
  - (c) secure main purchase;
  - (d) heave in topping lift;
  - (e) avast;
  - (f) choke the topping lift;
  - (g) check away main purchase;
  - (h) avast; and
  - (i) secure main purchase.

#### SAFETY INFRACTIONS

1. Not wearing a hard hat.
2. Not wearing issued cadet boots.
3. Running.
4. Horseplay.
5. Walking with an open knife.
6. Stepping over tackles under tension.
7. Putting hand through tackles when choking.
8. Putting hands/fingers on a block when the tackle is under tension.

THIS PAGE INTENTIONALLY LEFT BLANK

### SHEERS SCORESHEET

Group	Overall Time/Points Conversion	Points for Operating the Sheers (35 point maximum)	Penalties (-)	Total Score
Example	4 min, 20 sec = 420 1 000 - 420 = 580	35	5	610

- Notes:**
1. The overall time will be converted into points and subtracted from 1000. For example, a time of 4 minutes and 20 seconds will be converted to 1000 minus 420 points, to give a score of 580.
  2. When operating the sheers, five points will be given for every command followed properly.
  3. Penalties will be issued as follows:
    - a. 5 points for every part incorrectly labelled at Station 2,
    - b. 25 points if mousing comes off too easily, and
    - c. 50 points for every safety infraction (IAW Annex C) while operating the sheers.
  4. The total score will be the points for the overall time plus the points for operating the sheers, minus any penalties.

THIS PAGE INTENTIONALLY LEFT BLANK

**PARTS CARDS – STANDING DERRICK**

<b>TOPPING LIFT</b>	<b>SHOE</b>
<b>STROP</b>	<b>SIDE GUY</b>
<b>MAIN PURCHASE</b>	<b>LEADING BLOCK</b>
<b>SPAR</b>	<b>THUMB PIECE/ROPE COLLAR</b>
<b>MARTINGALE/FORE GUY</b>	<b>HEEL TACKLE</b>

THIS PAGE INTENTIONALLY LEFT BLANK

### STANDING DERRICK

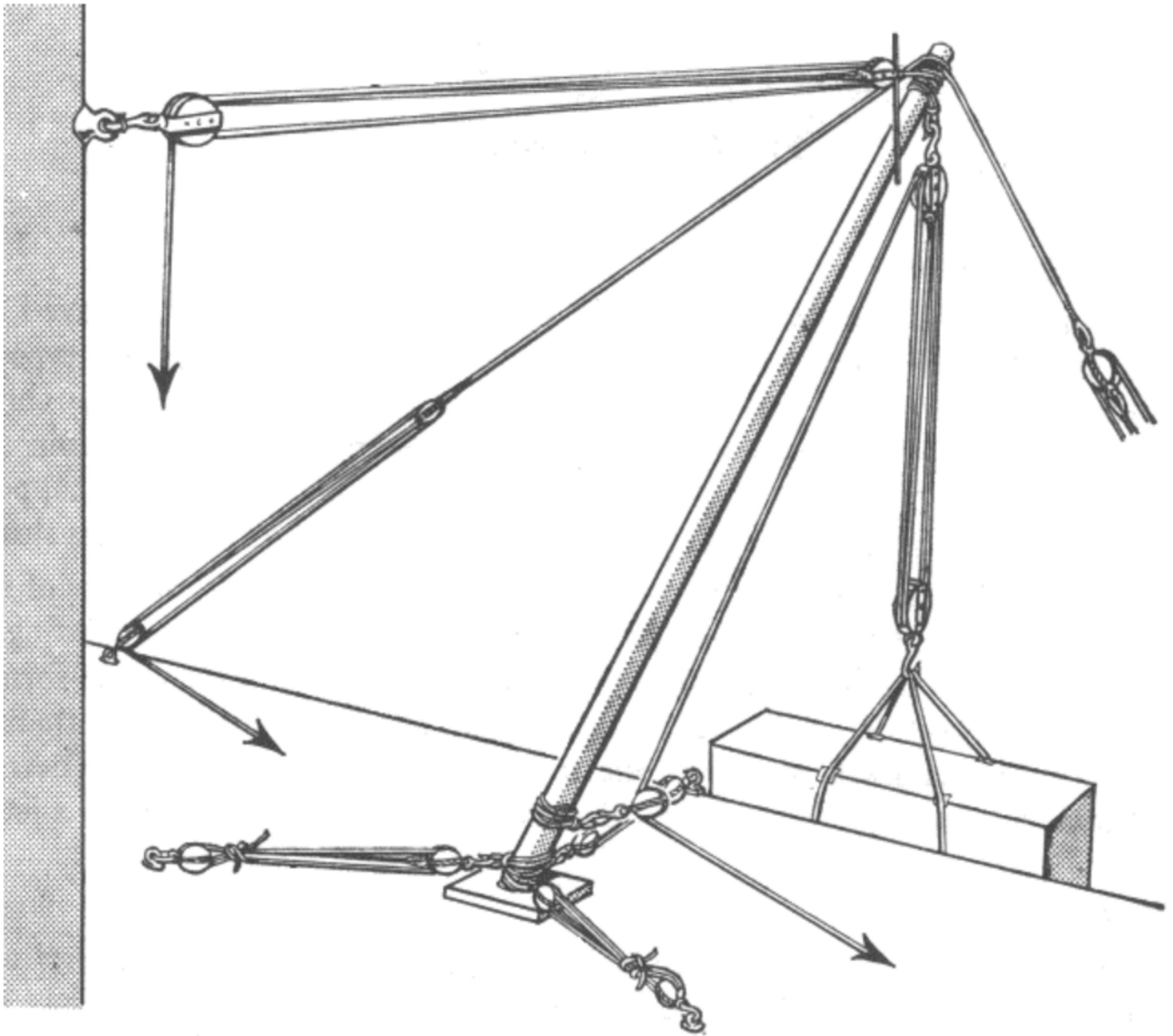

*Royal Navy, Admiralty Manual of Seamanship, Her Majesty's Stationery Office (p. 195)*

Figure 12F-1 Standing Derrick

THIS PAGE INTENTIONALLY LEFT BLANK



### SEQUENCE FOR STATION 3 – OPERATING A STANDING DERRICK



The standing derrick will be positioned with the topping lift checked away and the head of the derrick on the ground. The main purchase is slackened to allow the running block to be hooked onto the load before the derrick is raised.

The following sequence will be followed by each group for Station 3:

1. hook on the load (hook must be moused – five points;
2. respond to the following commands – five points each:
  - (a) heave in topping lift;
  - (b) avast;
  - (c) heave in main purchase;
  - (d) avast;
  - (e) heave in topping lift, check away guys;
  - (f) avast;
  - (g) heave in port guy, check away starboard guy;
  - (h) avast;
  - (i) heave in starboard guy, check away port guy;
  - (j) avast;
  - (k) check away main purchase;
  - (l) avast; and
3. unhook the load – five points.

#### SAFETY INFRACTIONS

1. Not wearing a hard hat.
2. Not wearing issued cadet boots.
3. Running.
4. Horseplay.
5. Walking with an open knife.
6. Stepping over tackles under tension.
7. Putting a hand through tackles when choking.
8. Putting hands/fingers on a block when the tackle is under tension.

THIS PAGE INTENTIONALLY LEFT BLANK

### STANDING DERRICK SCORESHEET

Group	Overall Time/Points Conversion From Station 1 & 2 (Subtracted From 1000)	Points for Operating the Standing Derrick From Station 3 (35 point maximum)	Penalties (-)	Total Score
Example	4 min, 20 sec = 420 1000 - 420 = 580	35	5	610

- Notes:**
1. The overall time will be converted into points and subtracted from 1000. For example, a time of 4 minutes and 20 seconds will be converted to 1000 minus 420 points, to give a score of 580.
  2. While operating the standing derrick, five points will be given for every command followed properly.
  3. Penalties will be issued as follows:
    - a. 5 points for every incorrectly labelled part at Station 1,
    - b. 25 points if mousing comes off too easily, and
    - c. 50 points for every safety infraction (IAW Annex G) while operating the standing derrick.
  4. The total score will be the points for the overall time plus the points for operating the sheers, minus any penalties.

THIS PAGE INTENTIONALLY LEFT BLANK

**PARTS CARDS – GYN**

<b>SPLAY TACKLE</b>	<b>SHOE</b>
<b>STROP</b>	<b>HEAD LASHING</b>
<b>MAIN PURCHASE</b>	<b>LEADING BLOCK</b>
<b>SPAR</b>	<b>THUMB PIECE/ ROPE COLLAR</b>

THIS PAGE INTENTIONALLY LEFT BLANK

**ASSEMBLED GYN**

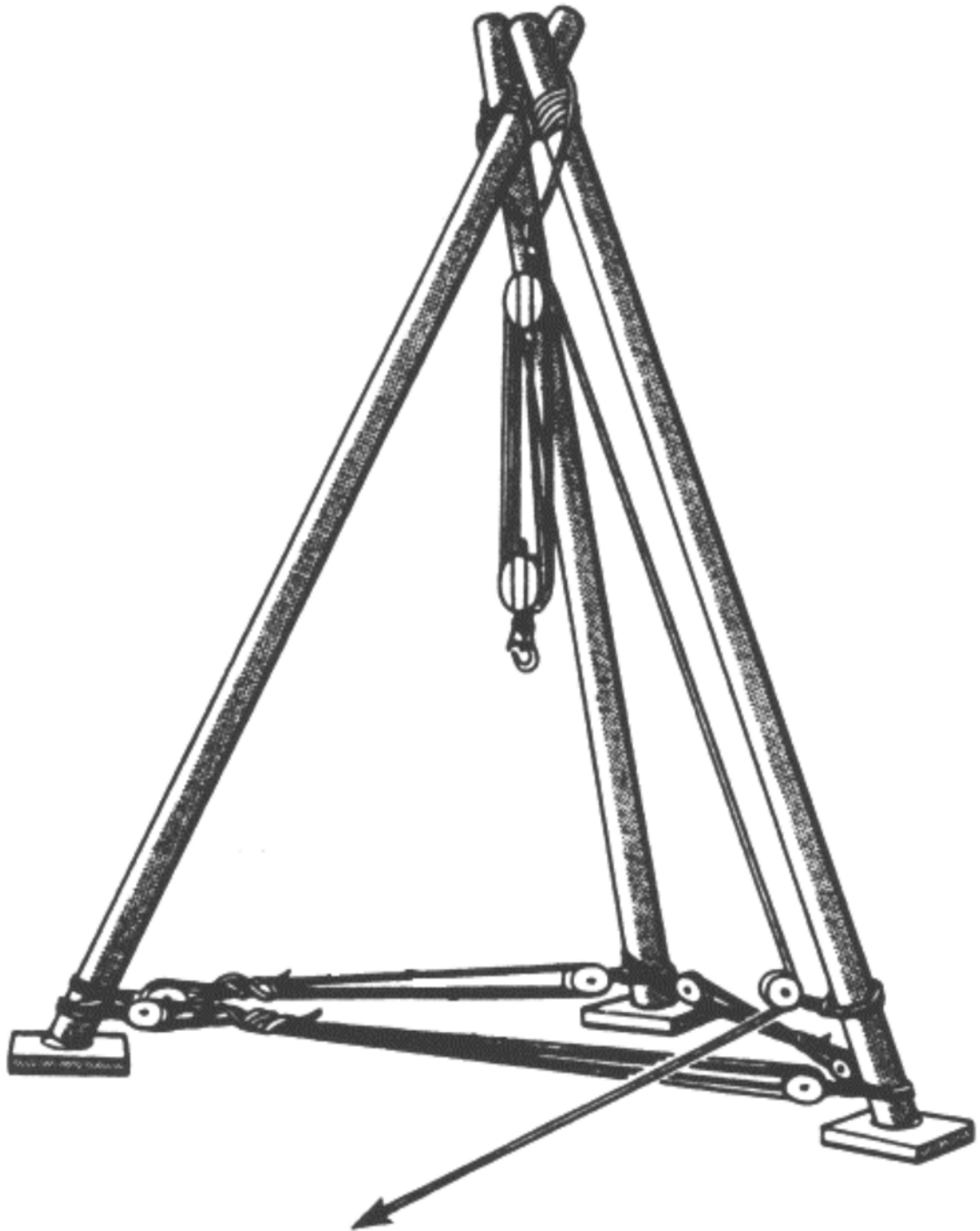

*Royal Navy, Admiralty Manual of Seamanship 1967 (Vol. 2), Her Majesty's Stationery Office (p. 198)*

Figure 12J-1 Assembled Gyn

THIS PAGE INTENTIONALLY LEFT BLANK



### SEQUENCE FOR STATION 3 – OPERATING A GYN



The gyn will be fully rigged with the main purchase checked away to allow the running block to be hooked onto the load.

The following sequence will be followed by each group for Station 3:

1. hook on the load (hook must be moused) – five points;
2. respond to the following commands – five points each:
  - (a) heave in main purchase;
  - (b) avast;
  - (c) secure main purchase;
  - (d) check away main purchase;
  - (e) avast; and
3. unhook the load – five points.

#### **SAFETY INFRACTIONS**

1. Not wearing a hard hat.
2. Not wearing issued cadet boots.
3. Running.
4. Horseplay.
5. Walking with an open knife.
6. Stepping over tackles under tension.
7. Putting hand through tackles when choking.
8. Putting hands/fingers on a block when the tackle is under tension.

THIS PAGE INTENTIONALLY LEFT BLANK

### GYN SCORESHEET

Group	Overall Time/Points Conversion	Points for Operating the Gyn (35 point maximum)	Penalties (-)	Total Score
Example	4 min, 20 sec = 420 1000 - 420 = 580	35	5	610

- Notes:**
1. The overall time will be converted into points and subtracted from 1000. For example a time of 4 minutes and 20 seconds will be converted to 1000 minus 420 points, to give a score of 580.
  2. When operating the gyn, five points will be given for every command followed properly.
  3. Penalties will be issued as follows:
    - a. 5 points for every part incorrectly labelled at Station 1,
    - b. 25 points if mousing comes off too easily, and
    - c. 50 points for every safety infraction (IAW Annex K) while operating the gyn.
  4. The total score will be the points for the overall time plus the points for operating the gyn, minus any penalties.

THIS PAGE INTENTIONALLY LEFT BLANK

## ALTERNATIVE METHOD FOR MAKING A MONKEY'S FIST

### EQUIPMENT LIST

- 4 mm (3/16 inch) diameter line (cord),
- Corkboard or cardboard square,
- Straight pins,
- 25 mm (1 inch) diameter wooden or cork ball,
- Tape,
- Cutting tool, and
- Monkey's fist pattern.

### KNOT WEAVING

#### Introduction

As knots become more complicated, it becomes difficult to keep track of where cords are to be woven. One method of weaving intricate knots is the use of a knot-weaving board. The board consists of wood, cork or cardboard that allows a knot pattern to be affixed by pins or nails. The cord is woven around the pins following a given pattern which indicates the direction and where cords will cross under or over each other. The pins maintain the desired shape of the knot until it is complete.

#### Knot Patterns

To make knot weaving easier, a series of arrows, dots, circles, lines and numbers are used on the knot patterns. They are as follows:

- An outlined arrow with the word "START" indicates the starting position and the initial direction for laying the cord.
- The numbers are placed at alternate crossings on the diagram and are to be followed consecutively during the weaving process.
- A circle at a crossing indicates an underpass of a cord already there.
- A crossing with no circle indicates an overpass of a cord already there.
- A feathered arrow indicates the end of the pattern.
- Small dots on the pattern indicate the turning points and the placement of pins.

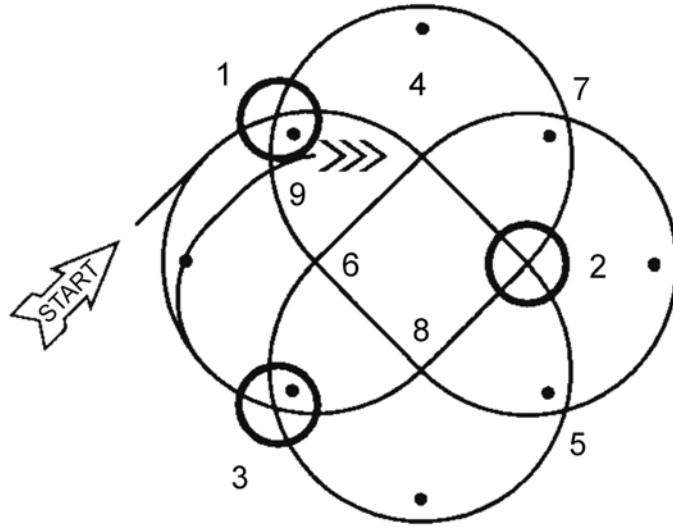

*D. Fukuhara, Fancy Knotting: An Introduction, David Fukuhara (p. 11)*

Figure 12M-1 Typical Knot Pattern

### Scaling a Pattern

Each knot pattern is drawn on a square grid. This allows for visualization of the knot pattern and easy identification of which crossover points are overpasses and which are underpasses.

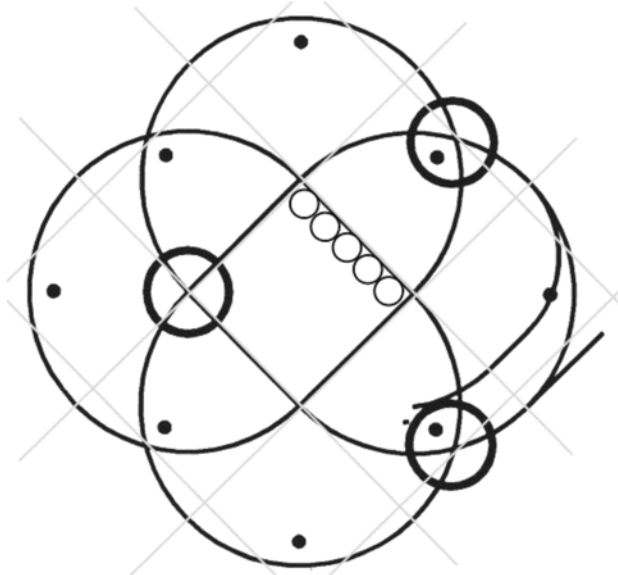

*Director Cadets 3, 2007, Ottawa, ON: Department of National Defence*

Figure 12M-2 Pattern Grid

Diameter of Cord	Length of Square's Side*
4 mm (3/16 inch)	20 mm (3/4 inch)
6 mm (1/4 inch)	30 mm (1 1/4 inch)
9 mm (3/8 inch)	45 mm (1 7/8 inch)
12 mm (1/2 inch)	60 mm (2 1/2 inch)
*This chart is based on a three-lead pattern. To change the number of leads in the pattern, add or subtract a cord diameter from the square's side measurement accordingly.	

*Director Cadets 3, 2007, Ottawa, ON: Department of National Defence*

Figure 12M-3 Pattern Scaling Chart

You can use the pattern for different sizes of line by scaling the size of the squares. The sides of squares should be roughly five cord diameters in length. The following guide may be used:



The term “lead” refers to a cord that follows the knot pattern to completion. For example, a three-lead knot has the cord following the pattern to completion three times.

### Length of Cord

The length of cord required to weave the knot can be determined before weaving. With the pattern on the knot-weaving board, put a pin at each turning point. Pin one end of the uncut cord at the starting point. Lay the cord on the pattern following the numbers from start to finish ignoring the underpasses. Mark this length with a piece of tape. After removing the cord, cut a length of cord equal to three times this measurement and add 30 cm (12 inches). The extra length will allow for hiding the ends in the middle of the knot.

### STEPS FOR MAKING A MONKEY'S FIST



Hand out the monkey's fist pattern located at Annex N to each cadet.

1. Cut out the monkey's fist pattern located at Annex N.
2. With the pattern on a knot-weaving board, put a straight pin at each turning point (as illustrated in Figure 12M-4).

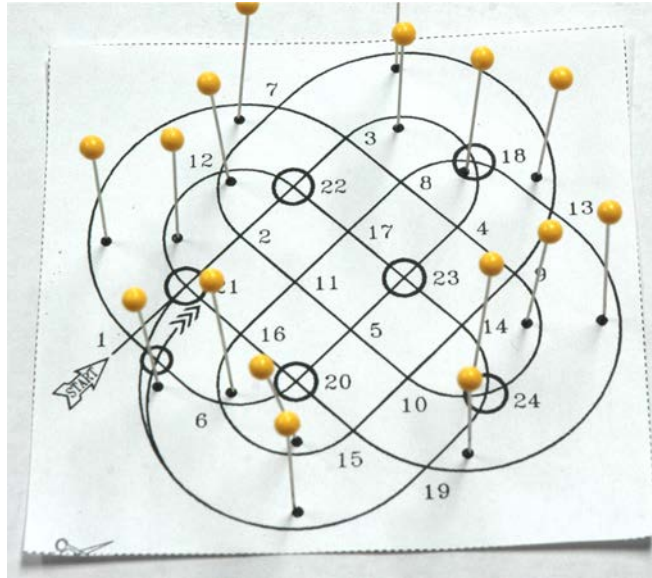

Director Cadets 3, 2008, Ottawa, ON: Department of National Defence

Figure 12M-4 Step 2

3. Lay the cord onto the pattern following the numbers from start to finish ignoring the underpasses (as illustrated in Figure 12M-5). Mark the one-third position and remove the cord from the pattern. Cut the cord to a length equal to three times the one-third length plus 30 cm (12 inches).

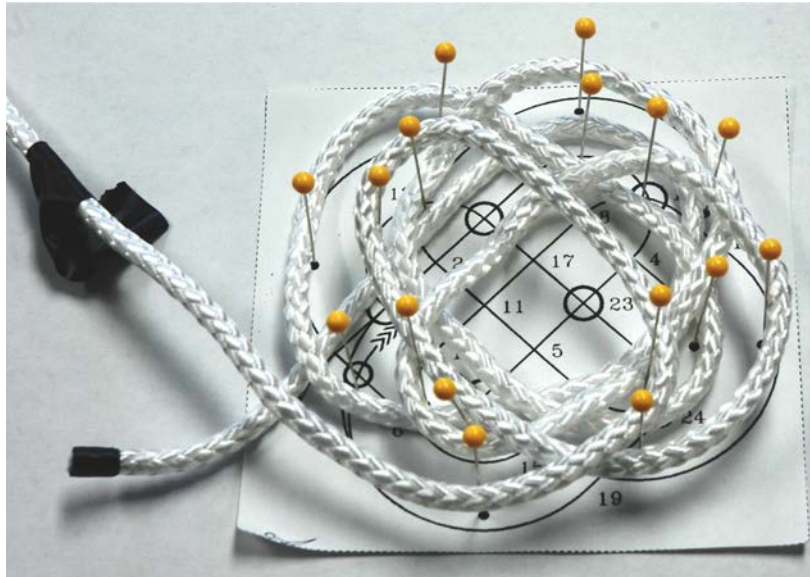

Director Cadets 3, 2008, Ottawa, ON: Department of National Defence

Figure 12M-5 Step 3

4. Pin the cord's one-third position onto the outlined arrowhead at the starting point (as illustrated in Figure 12M-6).
5. Lay the shorter length of cord onto the pattern following the numbers. At the turns, lay the cord around the pins and continue (as illustrated in Figure 12M-6). Pay attention to the underpasses at crossings with circles.



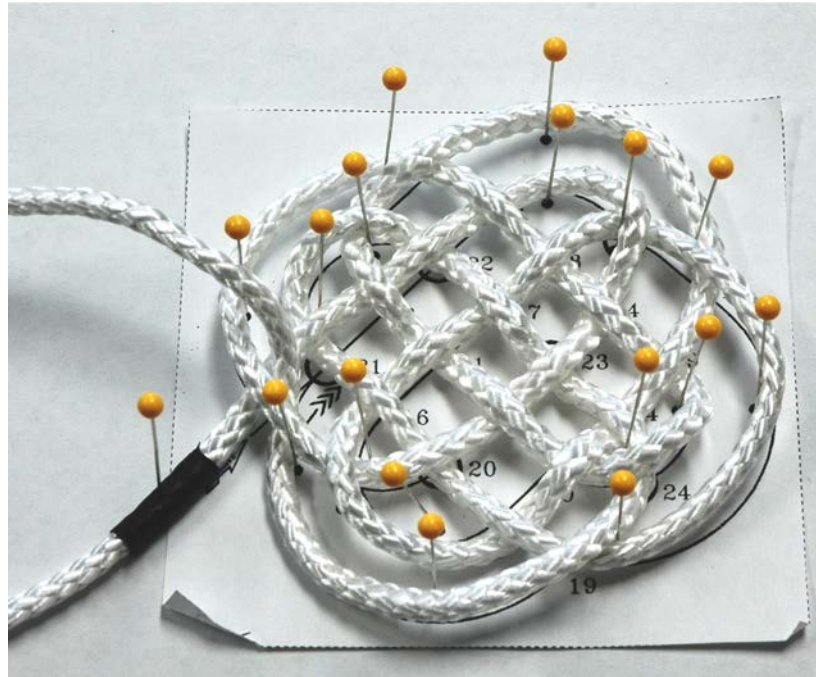

*Director Cadets 3, 2008, Ottawa, ON: Department of National Defence*

Figure 12M-6 Steps 4 and 5

6. When the cord is back to crossing number 1, the initial weaving sequence is complete. Check to ensure that the over and under sequence has been maintained from start to finish.



Any errors must be corrected now.

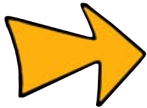

Once the initial lay of cord is complete, the pattern is no longer required.

7. Lay the remaining two-thirds of the cord following the previously laid cord in the opposite direction (as illustrated in Figure 12M-7).

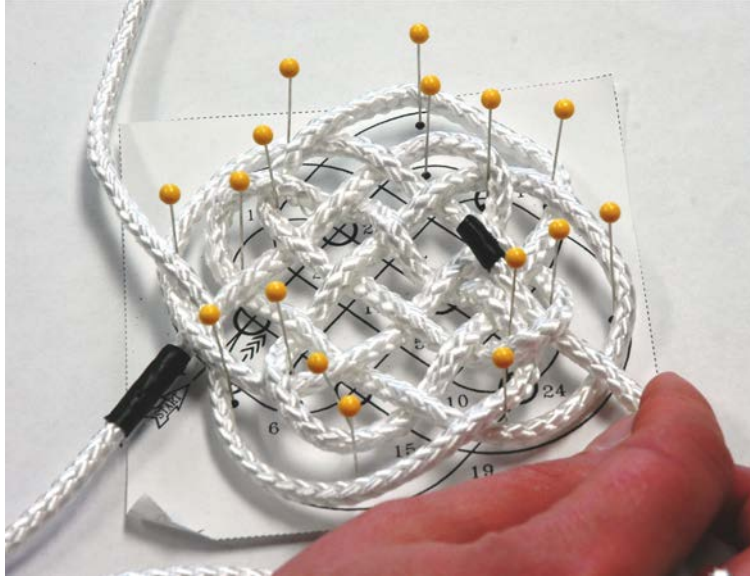

*Director Cadets 3, 2008, Ottawa, ON: Department of National Defence*

Figure 12M-7 Step 7

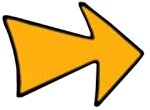

Weaving may be done on the board or by hand after removing the pins.

8. Continue until you have the correct number of leads required (as illustrated in Figure 12M-8).



*Director Cadets 3, 2008, Ottawa, ON: Department of National Defence*

Figure 12M-8 Step 8

9. After the weaving is complete, the slack must be taken out in small increments. The first part of the tightening is done without the cork or wooden ball inside (as illustrated in Figure 12M-9).



*Director Cadets 3, 2008, Ottawa, ON: Department of National Defence*

Figure 12M-9 Step 9

10. Once the original opening begins to close, insert the cork or wooden ball (as illustrated in Figure 12M-10). The knot should be moulded around the ball in a circular motion using the palms of the hands until the original opening is no longer evident.



*Director Cadets 3, 2008, Ottawa, ON: Department of National Defence*

Figure 12M-10 Step 10

11. Use a small fid or something pointed to pick and pull each cord into a firm tension.



When the last parts of the cord are tensioned, there is a tendency for the loose loop of cord to twist as it passes through the tightened sections. To prevent this twisting, maintain tension on the loop in one hand as the cord is drawn through, until it can no longer be easily grasped. The short loop should tuck in with little or no twist in it.

12. To finish the knot, the ends of the cord can be tied together to form a loop to attach to a heaving line. If the knot was tied on the end of a heaving line, lay the smaller end alongside the heaving line, whip them together for a short distance and cut off the excess (as illustrated in Figure 12M-11).



As this monkey's fist is constructed using the weaving method, the ends will not exit the knot from the same location.



*Director Cadets 3, 2008, Ottawa, ON: Department of National Defence*

Figure 12M-11 Step 12

### MONKEY'S FIST PATTERN

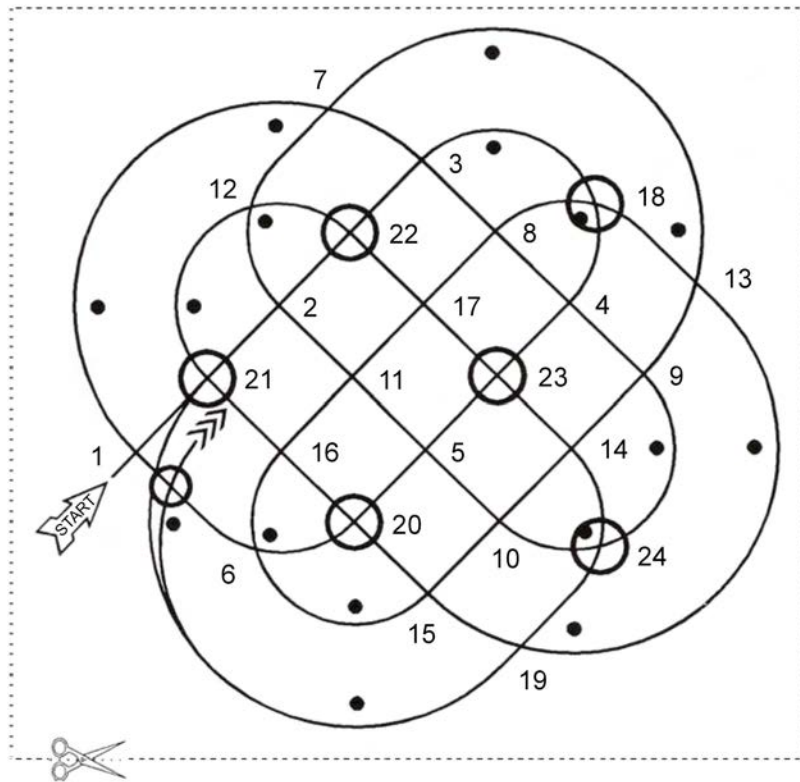

*D. Fukuhara, Fancy Knotting: An Introduction, David Fukuhara (p. 42)*

Figure 12N-1 Monkey's Fist Pattern

THIS PAGE INTENTIONALLY LEFT BLANK

## ALTERNATIVE METHOD FOR MAKING A TURK'S HEAD

### EQUIPMENT LIST

- 4 mm (3/16 inch) diameter line (cord),
- 40 mm (1 1/2 inch) thick foam,
- Straight pins,
- Paper clip,
- Transparent tape,
- Glue,
- Cutting tool, and
- Turk's head pattern.

### KNOT WEAVING – CYLINDER METHOD

#### Introduction

As knots become more complicated, it becomes difficult to keep track of where cords are to be woven. One method of weaving intricate knots is the use of a knot-weaving cylinder. The cylinder consists of a rolled up piece of foam that allows a knot pattern to be affixed using tape or pins. The cord is woven around the pins following a given pattern, which indicates direction and where cords will cross under or over. The foam and pins maintain the desired shape of the knot until it is complete.

#### Knot Patterns

To make knot weaving easier, a series of arrows, dots, circles, lines and numbers are used on the knot patterns. They are as follows:

- An outlined arrow with the word "START" indicates the starting position and the initial direction for laying the cord.
- The numbers are placed at alternate crossings on the diagram and are to be followed consecutively during the weaving process.
- A circle at a crossing indicates an underpass of a cord already there.
- A crossing with no circle indicates an overpass of a cord already there.
- A feathered arrow indicates the end of the pattern.
- Small dots on the pattern indicate the turning points and the placement of pins.
- Two arrowheads at each end of the diagram aid in the alignment.

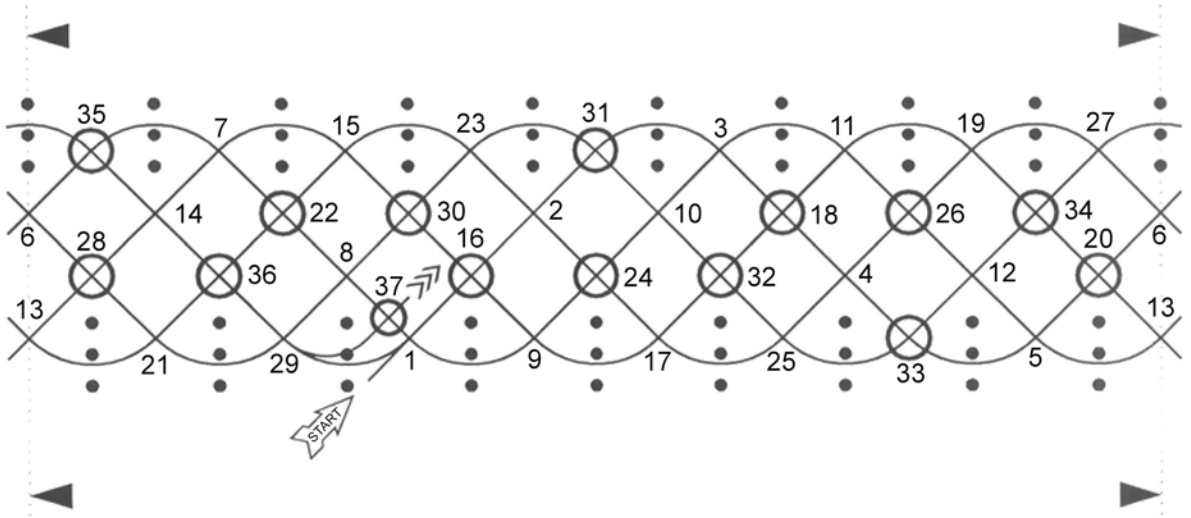

*D. Fukuhara, Fancy Knotting: An Introduction, David Fukuhara (p. 11)*

Figure 12O-1 Typical Knot Pattern—Cylinder Method

### Scaling a Pattern

Each knot pattern is drawn on a square grid. This allows for visualization of the knot pattern and easy identification of which crossover points are overpasses and which are underpasses.

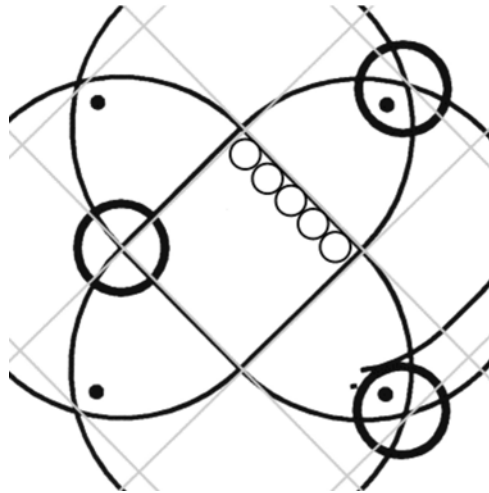

*Director Cadets 3, 2007, Ottawa, ON: Department of National Defence*

Figure 12O-2 Pattern Grid

By scaling the size of the squares, you can use the pattern for different sizes of line. The sides of the squares should be roughly five times the diameter of the cord. The following guide may be used:



Diameter of Cord	Length of Square's Side*
4 mm (3/16 inch)	20 mm (3/4 inch)
6 mm (1/4 inch)	30 mm (1 1/4 inch)
9 mm (3/8 inch)	45 mm (1 7/8 inch)
12 mm (1/2 inch)	60 mm (2 1/2 inch)
*This chart is based on a three-lead pattern. To change the number of leads in the pattern, add or subtract a cord diameter from the square's side measurement accordingly.	

*Director Cadets 3, 2007, Ottawa, ON: Department of National Defence*

Figure 12O-3 Pattern Scaling Chart



The term “lead” refers to a cord that follows the knot pattern to completion. For example, a three-lead knot has the cord following the pattern to completion three times.

### Length of Cord

The length of cord required to weave the knot can be determined before weaving. With the pattern on the knot-weaving cylinder, put a pin at each turning point. Pin one end of the uncut cord at the starting point. Lay the cord on the pattern following the numbers from start to finish ignoring the underpasses. Mark this length with a piece of tape. After removing the cord, cut a length of cord equal to three times this measurement and add 30 cm (12 inches). The extra length will allow the ends to be hidden in the middle of the knot.

### STEPS FOR MAKING A TURK'S HEAD



Hand out the turk's head pattern located at Annex P to each cadet.



The turk's head pattern used for this lesson will make a decorative bracelet that can be worn around the wrist. The turk's head may also be used to decorate a cylindrical object by placing it over the end of the object and heaving each lead taut.

1. Cut out the turk's head pattern located at Annex P. Ensure that the pattern is cut out on the outside dotted line, leaving room for the pattern to overlap.
2. Using transparent tape, join the points of the arrowheads on the pattern together so that the pattern forms a cylinder (as illustrated in Figure 12O-4).

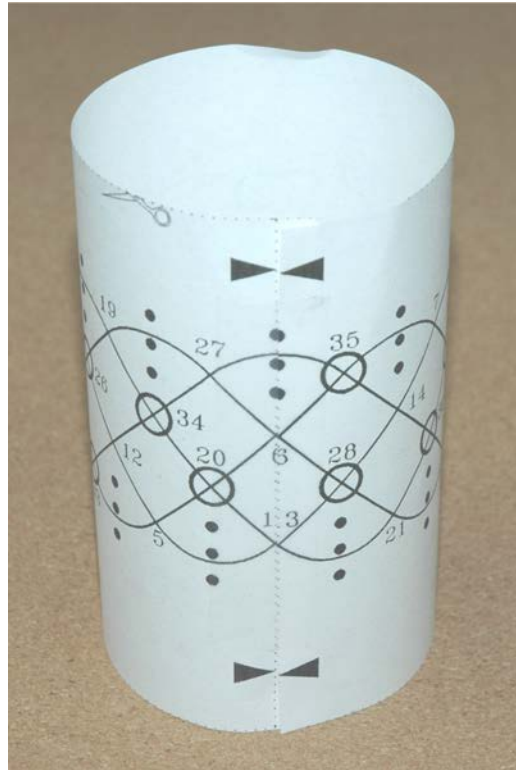

*Director Cadets 3, 2008, Ottawa, ON: Department of National Defence*

Figure 12O-4 Step 2

3. Roll up a piece of foam and insert it into the pattern cylinder created in Step 2. Allow the foam to expand inside the pattern cylinder (as illustrated in Figure 12O-5).

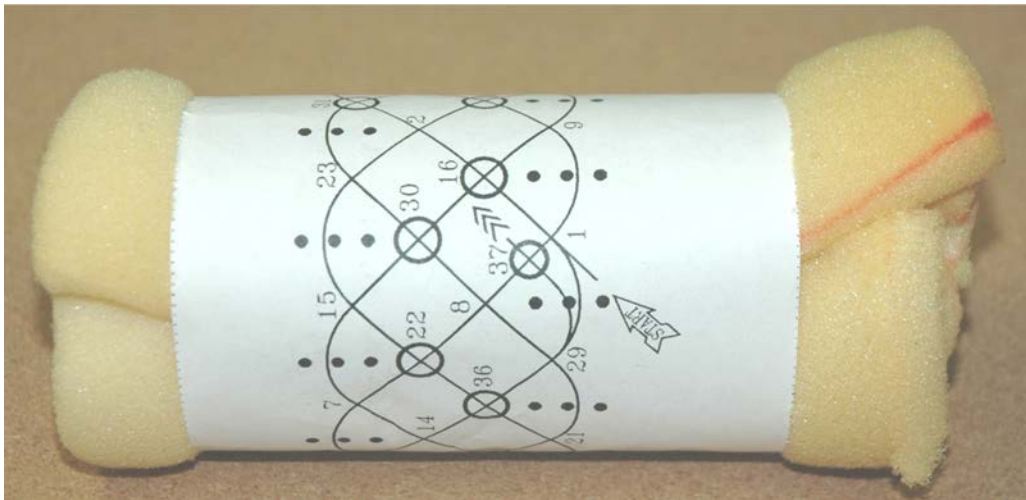

*Director Cadets 3, 2008, Ottawa, ON: Department of National Defence*

Figure 12O-5 Step 3



If a larger piece of foam can be forced into the pattern cylinder, the foundation for making the turk's head will be firmer.

4. Insert straight pins through the dots printed on the pattern (as illustrated in Figure 12O-6). Leave 13 mm (1/2 inch) of each pin protruding to hold the cord in place as the turk's head is made.

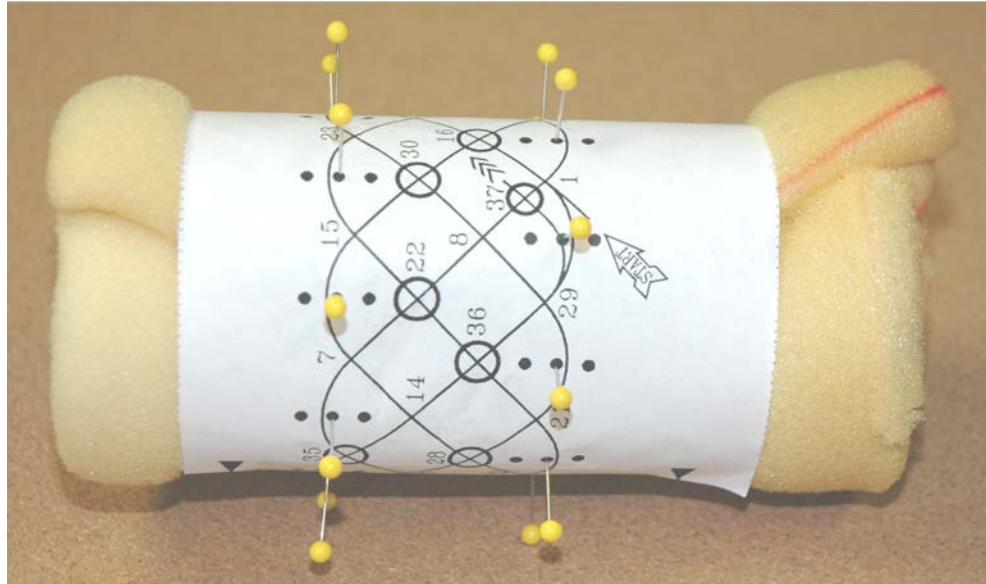

*Director Cadets 3, 2008, Ottawa, ON: Department of National Defence*

Figure 12O-6 Step 4



There are three rows of dots on the turk's head pattern, located at Annex P, that are used for making different sized turk's heads. The outer row is used to make a larger diameter turk's head and the inner row is used to make a smaller one.

5. Lay the cord onto the pattern following the numbers from start to finish ignoring the underpasses (as illustrated in Figure 12O-7). Mark the one-third position and remove the cord from the pattern. Cut the cord to a length equal to three times the one-third length plus 30 cm (12 inches).

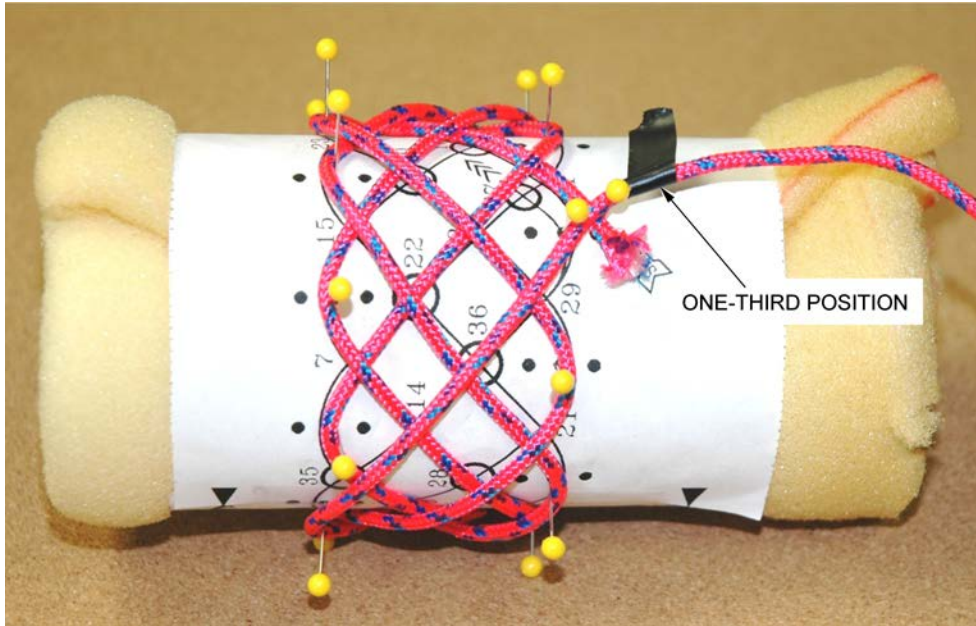

Director Cadets 3, 2008, Ottawa, ON: Department of National Defence

Figure 12O-7 Step 5

6. Pin the cord's one-third position onto the outlined arrowhead at the starting point and wrap the one-third length around the blank portion of the cylinder (as illustrated in Figure 12O-8). Pin this one-third length to the cylinder to keep it neat for later use.

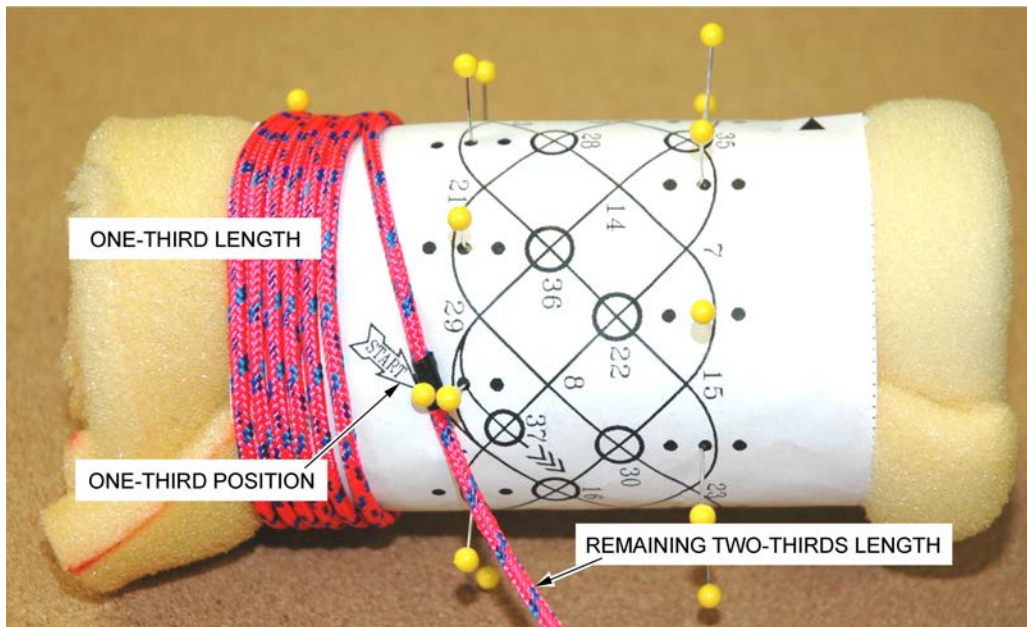

Director Cadets 3, 2008, Ottawa, ON: Department of National Defence

Figure 12O-8 Step 6

7. Bend a paper clip to make a weaving needle (as illustrated in Figure 12O-9) and attach to the working end of the longer length of cord (the two-thirds length).



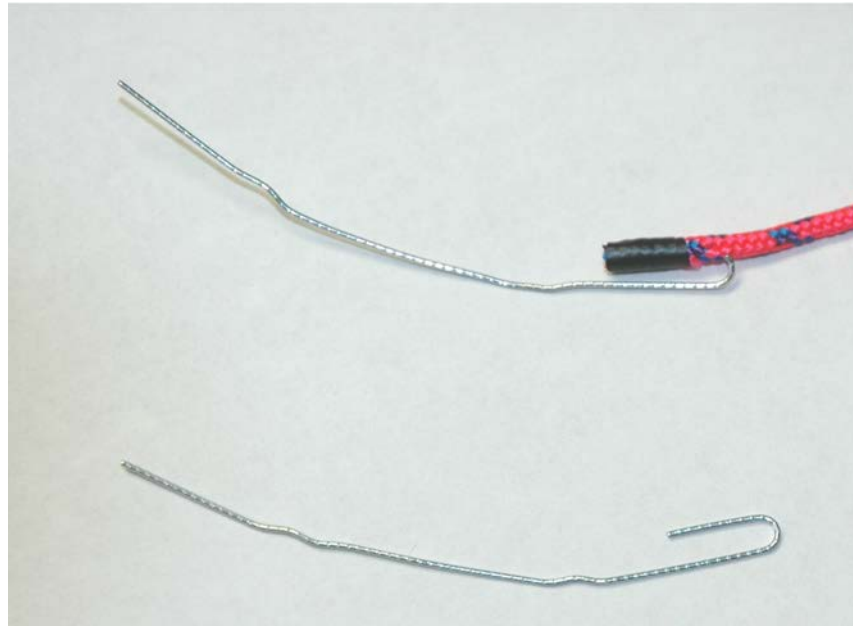

*Director Cadets 3, 2008, Ottawa, ON: Department of National Defence*

Figure 12O-9 Step 7

8. Lay the longer length of cord (the two-thirds length) onto the pattern following the numbers. At the turns, lay the cord around the pins and continue. Use the weaving needle to pass the cord under any previously-laid cords at a circled crossing (as illustrated in Figure 12O-10).

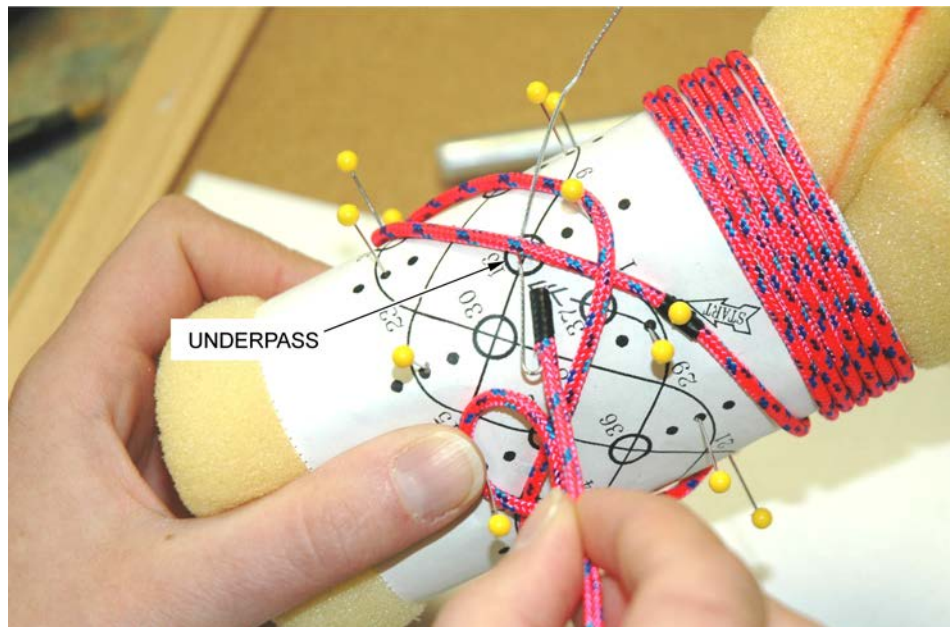

*Director Cadets 3, 2008, Ottawa, ON: Department of National Defence*

Figure 12O-10 Step 8

9. When crossing number 37 is reached, check the weaving for any errors.



Correct any errors before proceeding to the next step.

10. Continue laying the cord side by side to the initial cord (as illustrated in Figure 12O-11) following it under or over at the crossings. When the cord reaches a turn and must pass on the inside of its arc (between the initial cord and a pin), remove the pin, lay the new cord beside the initial cord and re-insert the pin inside the new arc (as illustrated in Figure 12O-12). Moving the pin will maintain the overall shape of the turk's head.

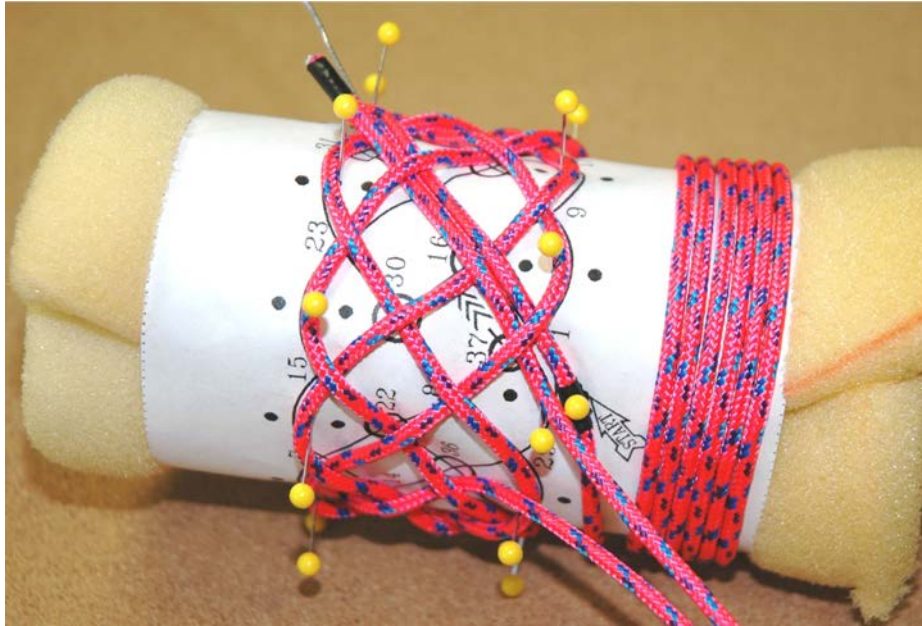

*Director Cadets 3, 2008, Ottawa, ON: Department of National Defence*

Figure 12O-11 Step 10

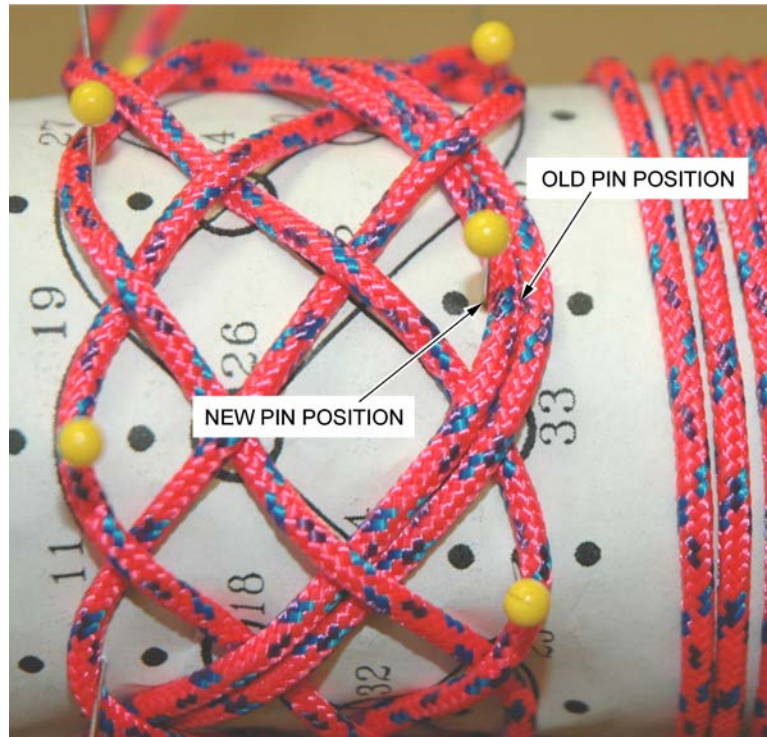

*Director Cadets 3, 2008, Ottawa, ON: Department of National Defence*

Figure 12O-12 Moving a Turn Pin



Crossing number 37 on the pattern located in Annex P, is the same as crossing number 1.

11. When the cord is back to the start, undo the one-third length that was wound around the cylinder in Step 6, and lay it side-by-side to the cords previously laid but in the opposite direction (as illustrated in Figure 12O-13). Ensure that pins are moved on the inside arc of the turns (as illustrated in Figure 12O-12).



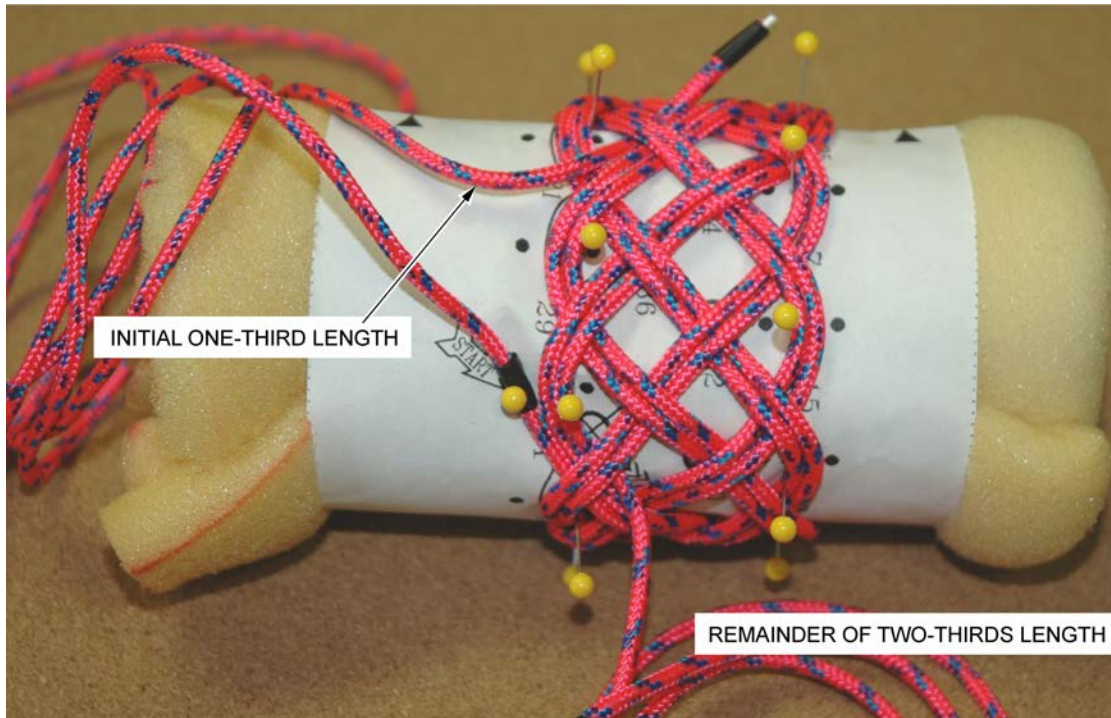

*Director Cadets 3, 2008, Ottawa, ON: Department of National Defence*

Figure 12O-13 Step 11

12. When the turk's head shows three cords side-by-side everywhere, the weaving is complete. Remove the pins from the pattern and slide the turk's head from the cylinder. Ensure that the ends meet inside the turk's head and not on the outer rim (as illustrated in Figure 12O-14).



*Director Cadets 3, 2008, Ottawa, ON: Department of National Defence*

Figure 12O-14 Step 12

13. To finish the turk's head, the cord can be glued to its adjacent cord for a length equal to four times the diameter of the cord and the excess cord can be trimmed (as illustrated in Figure 12O-15).





*Director Cadets 3, 2008, Ottawa, ON: Department of National Defence*

Figure 12O-15 Step 13



An alternative to finishing the turk's head is to sew the cord to its adjacent cord for a length equal to four times the diameter of the cord and then trim the excess.

14. The turk's head bracelet is now complete and ready to wear (as illustrated in Figure 12O-16).



*Director Cadets 3, 2008, Ottawa, ON: Department of National Defence*

Figure 12O-16 Finished Turk's Head Bracelet

THIS PAGE INTENTIONALLY LEFT BLANK

### TURKS HEAD PATTERN

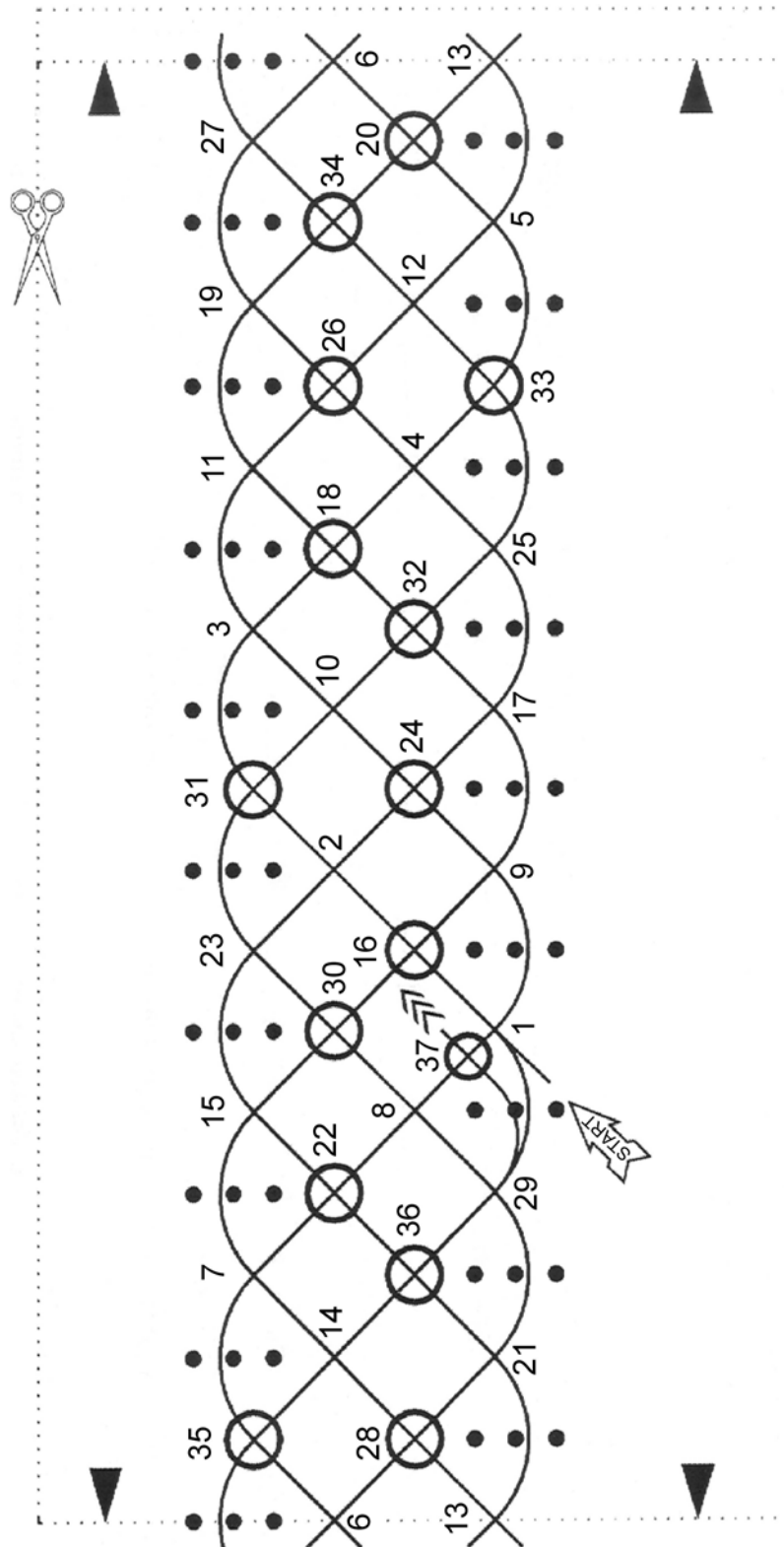

*D. Fukuhara, Fancy Knotting: An Introduction, David Fukuhara (p. 23)*

Figure 12P-1 Turk's Head Pattern

THIS PAGE INTENTIONALLY LEFT BLANK

**CHAPTER 13**

**PO 322 – ATTAIN PLEASURE CRAFT OPERATOR COMPETENCY**





**ROYAL CANADIAN SEA CADETS**

**ALL TRAINING LEVELS**

**INSTRUCTIONAL GUIDE  
SHIPS OPERATIONS**



**PO 322 – ATTAIN PLEASURE CRAFT OPERATOR COMPETENCY**

---

Total Time:

---

This PO and its associated EOs are located in A-CR-CCP-921/PG-001, *Canadian Cadet Organizations Small Craft Operator Program (SCOP), Module 1 – Pleasure Craft Operator Competency*.

THIS PAGE INTENTIONALLY LEFT BLANK



**CHAPTER 14**  
**PO 323 – SERVE IN A NAVAL ENVIRONMENT**





## ROYAL CANADIAN SEA CADETS

### PHASE THREE

### INSTRUCTIONAL GUIDE



### SECTION 1

### EO M323.01 – PERFORM CORPS DUTIES

Total Time:

60 min

### PREPARATION

#### PRE-LESSON INSTRUCTIONS

Resources needed for the delivery of this lesson are listed in the lesson specification located in A-CR-CCP-603/PG-001, Chapter 4. Specific uses for said resources are identified throughout the instructional guide within the TP for which they are required.

Review the lesson content and become familiar with the material prior to delivering the lesson.

The activity in TP 3 uses learning stations. Learning stations are a form of group work where the cadets learn by sorting through the information presented. When setting up learning stations, ensure there is enough room for each cadet to be comfortable and have adequate space to perform each duty. When the cadets arrive at a learning station, all required information shall be available. These stations should be placed closely together to minimize time for movement; however, far enough apart to avoid interruptions from other groups. For this lesson, set up three learning stations for the duties of a Quartermaster.

Photocopy the organizational charts located at Annexes A to C and the Quartermaster terms of reference located at Annex D for each cadet.

Photocopy the Quartermaster reference guide located at Annex E.

#### PRE-LESSON ASSIGNMENT

N/A.

#### APPROACH

An interactive lecture was chosen for TPs 1 and 2 as it allows the instructor to deliver new information on the duties of a Quartermaster and to involve the cadets by encouraging them to ask and respond to questions.

An in-class activity was chosen for TP 3 as it is an interactive way to allow the cadets to perform the duties of a Quartermaster under supervision.

### INTRODUCTION

#### REVIEW

N/A.

## OBJECTIVES

By the end of this lesson the cadet shall have described the corps structure and practiced the duties of Quartermaster.

## IMPORTANCE

It is important for cadets to describe the corps structure and become familiar with their chain of command as they become more involved in the ships' routine. The Quartermaster is an important role within the duty personnel organization and will ensure the conduct of corps' operations in an efficient manner.

---

### Teaching Point 1

### Explain the Corps' Structure

Time: 10 min

Method: Interactive Lecture

---



Distribute the organizational charts located at Annexes A to C.

## CORPS STRUCTURE

A corps is divided into three organizations. These organizations work co-operatively to delegate work and responsibility to the officers and cadets of the corps. This helps to ensure that no member is over-tasked or under-tasked and that no area of the corps is neglected.

### Functional Organization

The functional organization outlines the administrative responsibilities of the corps and is based upon the divisional system.

### Duty Personnel Organization

The duty personnel are a group of carefully selected officers and cadets. The duty personnel serve on a rotational basis to look after the safety, conduct and appearance of the corps and its ship's company.

### Training Organization

The training organization (as illustrated in Annex C) is responsible for the implementation of the Royal Canadian Sea Cadet Corps Training Program, as directed by the Director Cadets. Based on the size of the corps and the available instructors, the training organization may be structured in different ways. Two possible ways are:

- **Option One.** The Phase Course Officers serve as standards officers for each phase and complete any administration as required by the Training Officer. Each Phase Course Officer has a group of Phase instructors that instruct only one phase over the course of the training year. The instructors have a wide range of training backgrounds and collectively, are qualified to instruct all of the training.
- **Option Two.** The Phase Course Officers serve as standards officers for each phase and complete any administration as required by the Training Officer. Instructors are not dedicated to any one phase, but are organized into training departments based on their training backgrounds and are tasked by the Training Officer as required.



Discuss both training organization options with the cadets. Focus on the option used at the corps.

---

### CONFIRMATION OF TEACHING POINT 1

---

#### QUESTIONS

- Q1. What are the three organizations of a corps?  
 Q2. What is the functional organization based upon?  
 Q3. What is the function of the duty personnel?

#### ANTICIPATED ANSWERS

- A1. The three organizations of a corps are:
- functional organization,
  - duty personnel organization, and
  - training organization.
- A2. The divisional system.
- A3. To look after the safety, conduct and appearance of the corps and its ship's company.

---

#### Teaching Point 2

#### Describe the Duties of a Quartermaster

Time: 10 min

Method: Interactive Lecture

---



Distribute the Quartermaster terms of reference located at Annex D.

#### DUTIES OF A QUARTERMASTER

The Quartermaster serves an important role within the duty organization. This role along with the rest of the duty personnel helps to ensure the safety, conduct and appearance of the corps and its ship's company.



The following are some common abbreviations and terms used by duty personnel:

- **OOD.** Officer of the Day.
- **Coxn.** Coxswain.
- **POOD.** Petty Officer of the Day.
- **QM.** Quartermaster.



The cadets will have been introduced to the pipes required to carry out the duties of a QM in EO M223.04 (Pipe the General Call, A-CR-CCP-602/PF-001, Chapter 12, Section 4), EO M223.05 (Pipe the Still, A-CR-CCP-602/PF-001, Chapter 12, Section 5) and EO M223.06 (Pipe the Carry On, A-CR-CCP-602/PF-001, Chapter 12, Section 6).

### Running Colours and Sunset

The QM will prepare the ensign and organize the flag party at the beginning and end of each night. Corps may organize the flag party in one of the following ways:

- the Coxn maintains a schedule of Phase One and Two cadets, or
- Phase One and Two cadets are selected from the duty division.

As part of colours and sunset, the QM will be expected to address the Commanding Officer (CO) and pipe the Still and Carry On.



Colours and sunset ceremonies will vary at each corps depending on the layout of the parade square and the position of the ensign. The Coxn should brief the QM about the conduct of colours and sunset prior to their commencement.

### Maintaining the Corps' Routine and Controlling of the Corps' Broadcast System

The ship's routine relies on various sound signals and commands. As directed by the Coxn, the QM will ring the ship's bell and make general announcements such as hands to classes by making pipes or by using the corps' broadcast system.



The cadets were introduced to ringing the ship's bell in EO M123.03 (Ring a Ship's Bell, A-CR-CCP-601/PF-001, Chapter 11, Section 3) and may have been introduced to the 24-hour clock in EO C123.01 (Read the 24-Hour Clock, A-CR-CCP-601/PF-001, Chapter 11, Section 5).

### Controlling the Brow

While performing duties at the brow the QM will be responsible for the following:

- identifying all personnel coming aboard or leaving the ship (training location), to include:
  - saluting passing officers;
  - controlling the CO's and senior officer's absentee indicators; and
  - greeting visitors and directing them to the ship's office;
- ensuring that no unauthorized material is taken ashore; and
- controlling the ship's log, to include:
  - signing the logbook at the commencement and completion of duties;
  - recording when an individual enters or leaves the ship;
  - recording events in the logbook as directed by the OOD; and
  - ensuring the logbook does not go missing.

## Ensuring the Cleanliness of the Brow Area

The brow is a visitor's first impression of a corps. The QM will be responsible for ensuring the cleanliness of the brow area. The brow should be kept clear of any gash and clutter. The brow is not an area for cadets to muster or socialize.

---

### CONFIRMATION OF TEACHING POINT 2

---

#### QUESTIONS

- Q1. How does the corps organize which cadets are in the flag party?
- Q2. How is the QM responsible for running the corps' routine?
- Q3. Where should the QM direct visitors?

#### ANTICIPATED ANSWERS

- A1. Answers will vary depending on the corps.
- A2. The QM will be responsible to ring the ship's bell and make general announcements, such as hands to classes, by making pipes or by using the corps' broadcast system.
- A3. To the ship's office.

---

#### Teaching Point 3

#### Conduct an Activity Where the Cadets Will Practice the Duties of a Quartermaster

Time: 30 min

Method: In-Class Activity

---

### ACTIVITY

---

#### OBJECTIVE

The objective of this activity is to have the cadets perform the duties of a QM.

#### RESOURCES

- Boatswain's call,
- Cleaning supplies,
- Corps' broadcast system (if available),
- Ensign (or other flag),
- Ship's bell, and
- Quartermaster reference guide located at Annex E.

#### ACTIVITY LAYOUT

Set up three learning stations, to simulate:

- the brow,
- flag mast, and
- corps' broadcast system or a suitable training area to make pipes.



One instructor will be required at each of the learning stations. If the group of cadets is small, the instructor may take the cadets to each of the learning stations as one group.



Post the Quartermaster reference guide located at Annex E at the brow. Cadets will be able to refer to this when performing duties of the QM.

### ACTIVITY INSTRUCTIONS

1. Divide the cadets into three groups and place each group at one of the learning stations.



The exact duties of the Quartermaster will vary depending on the corps.

2. Using the Quartermaster reference guide and Quartermaster terms of reference as guides, have the cadets perform the duties required at the learning station.
3. After 10 minutes, have the groups rotate clockwise and perform the duties required at the next learning station.
4. Rotate the groups to the remaining station.
5. When the activity is completed, debrief the cadets and answer any questions.

### SAFETY

N/A.

---

### CONFIRMATION OF TEACHING POINT 3

---

The cadets' participation in the activity will serve as the confirmation of this TP.

---

### END OF LESSON CONFIRMATION

---

The cadets' participation in the duties of a QM learning stations will serve as the confirmation of this lesson.

---

### CONCLUSION

---

### HOMEWORK/READING/PRACTICE

N/A.

### METHOD OF EVALUATION

This EO is assessed IAW A-CR-CCP-603/PG-001, Chapter 3, Annex B, Appendix 5 (323 EC 01) and Chapter 3, Annex B, Appendix 6 (323 PC).



**CLOSING STATEMENT**

The ability to describe the corps structure and being familiar with the chain of command will become a requirement as the cadets become more involved in the ships' routine. The QM is an important role within the duty personnel organization and helps ensure the conduct of operations in a timely and efficient manner.

**INSTRUCTOR NOTES/REMARKS**

This EO should be conducted early in the year to allow the cadets to perform the duties of the Quartermaster during the training year.

---

**REFERENCES**

---

A1-047 Director Cadets 4. (1994). CATO 31-01, *Sea Cadets Corps' Standardized Standing Orders*. Ottawa, ON: Department of National Defence.

THIS PAGE INTENTIONALLY LEFT BLANK



## ROYAL CANADIAN SEA CADETS

### PHASE THREE

### INSTRUCTIONAL GUIDE



### SECTION 2

### EO C323.01 – COMMUNICATE USING FLAGS AND PENNANTS

---

Total Time: 120 min

---



---

### PREPARATION

---

#### PRE-LESSON INSTRUCTIONS

Resources needed for the delivery of this lesson are listed in the lesson specification located in A-CR-CCP-603/PG-001, Chapter 4. Specific uses for said resources are identified throughout the instructional guide within the TP for which they are required.

Review the lesson content and become familiar with the material prior to delivering the lesson.

Make five colour copies of the flag flash cards located at Annex F. Cut out and paste the flag flash cards onto card stock or heavy paper.

Photocopy and cut out the flag flash card results sheet located at Annex G for each group of five cadets.

Photocopy the signal mast handout located at Annex H for each cadet.

Photocopy two sets of the signal hoist cue cards located at Annex I. Cut out and paste them onto card stock or heavy paper.

Photocopy two signal hoist results sheet located at Annex J.

Photocopy the signal hoist answer key located at Annex K.

#### PRE-LESSON ASSIGNMENT

N/A.

#### APPROACH

An interactive lecture was chosen for TPs 1, 2, 4 and 5 to introduce the flags and pennants commonly used in sea cadet training.

An in-class activity was chosen for TPs 3 and 6 as it is an interactive way to confirm the cadets' knowledge of flags and pennants.

---

### INTRODUCTION

---

#### REVIEW

N/A.

## OBJECTIVES

By the end of this lesson the cadet shall have communicated a message using the given flags and pennants.

## IMPORTANCE

Flags and pennants are used extensively in the nautical environment as a means of visually communicating information to the vessel's crew, shore stations and other ships that are in sight. It is important for the cadets to recognize the meanings of flags and pennants as they may be the first person at a sail centre or on-water weekend to see signals from a vessel which could indicate distress or urgent situations.

---

### Teaching Point 1

### Explain Flags and Pennants

Time: 5 min

Method: Interactive Lecture

---

## PURPOSE

Before the invention of the radio, the only way mariners could pass messages from one ship to another was by means of visual signals. Strips of coloured cloth would be hoisted up the mast to send a predetermined signal which saved considerable time while afloat. These pieces of cloth have evolved into the distinctive shapes and patterns that make up the flags and pennants used today.

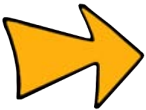

Flags, both alphabetical and numerical, are identifiable by their square shape. Flag ALPHA and BRAVO are actually burgees due to their distinctive V-shaped indentation but are referred to as flags due to their overall square shape.

Pennants are long and narrow and can be either triangular (three-sided) or quadrangular (four-sided).

In the present day, most communication between ships is accomplished electronically but flags and pennants are still used to communicate intentions, movements and general information to ships within visual range.



The meanings of the individual flags and pennants are referred to as signals or signal hoists when communicating to others.

When recording signals, the flags and pennants are written out in capital letters. Whenever possible, the abbreviation of the flag or pennant should be used.

## CALL SIGN

The call sign is a combination of an alphabetical designator that denotes the type or class of ship and a series of numerals that denote the hull designation within that class. Each call sign is unique and identifies the ship to other ships within sight. When sending signals within a group of ships, the use of a call sign will designate the addressee or whom the signal is addressed to.

An example of a call sign for *Raven 56* would be PAPA FIVE SIX, where:

- *PAPA* denotes the class of vessel is a patrol craft;
- *FIVE SIX* is the hull designation that denotes hull 56 within that class; and
- Hull 56 in the patrol craft class is named *Raven 56*.

## TACK LINE

A tack line (TACK) is a length of halyard approximately 2 m (6 feet) long; the exact length depends upon the size of flags in use. It is used:

- to avoid ambiguity by separating signals or groups of numerals on the same hoist which, if not separated, could convey a different meaning from that intended; or
- when, for the needs of a particular signal, the instructions order that a tack line be used.

An example of using a tack line is in the signal ALPHA TACK TWO where the ALPHA flag is followed by a tack line and the numerical flag TWO on the same hoist. The ALPHA flag is used to denote that friendly divers are working in the water. The addition of the tack line, followed by the numeral flag TWO denotes that the divers are working within 200 yards of the vessel. If the ALPHA flag and the TWO flag were hoisted together, they would be interpreted as another signal.

## COMBINING SIGNALS

Signals may be combined together in a group to send a specific meaning that is different than the individual flag or pennant's meaning. If the signals are not to be interpreted as a group, they must be separated by a tack line or hoisted on separate halyards.

A call sign is an example of where signals can be combined on one hoist.

---

## CONFIRMATION OF TEACHING POINT 1

---

### QUESTIONS

- Q1. What shape is a flag?
- Q2. What signal is used to designate an addressee?
- Q3. What must be used to separate signals on a single halyard if they are not to be interpreted as a group?

### ANTICIPATED ANSWERS

- A1. Square.
- A2. Call sign.
- A3. Tack line.

---

### Teaching Point 2

Time: 5 min

### Explain Signal Hoist Terms

Method: Interactive Lecture

---

### SIGNAL HOIST TERMS

**Bent on.** The signal flag is attached to the halyard, secured to a cleat and ready to be hoisted.

**Hoist.** To raise the signal flag.

**Close Up.** The signal flag is hoisted to the full extent of the halyard with the head of the flag touching the block.

**At the Dip.** The signal flag is hoisted to a position one-third of the halyard length from the top.

**Haul Down (Strike).** To lower the signal flag and remove from the halyard.

---

**CONFIRMATION OF TEACHING POINT 2**

---

**QUESTIONS**

- Q1. Where should a signal flag be if it is at the dip?
- Q2. What is the term used for lowering a signal flag?
- Q3. What does hoist mean?

**ANTICIPATED ANSWERS**

- A1. One-third of the halyard length from the top.
- A2. Haul down (strike).
- A3. To raise the signal flag.

---

**Teaching Point 3**

**Conduct an Activity Where the Cadets Will Identify and Describe the Meaning of Flags and Pennants**

Time: 40 min

Method: In-Class Activity





---



Introduce the flags and pennants from Figure 14-2-1 and conduct the activity to confirm the cadet's recognition of them.





**FLAG AND PENNANTS**

There are 14 common signals used in sea cadet training (as illustrated in Figure 14-2-1). Each signal may have a military and an International Code of Signals (INTERCO) meaning. When signals are hoisted on a military ship, the military meaning is assumed unless the CODE or ANSWER pennant (ANS) is also hoisted indicating to use the INTERCO meanings.

Signal	Example	Meaning	SCTV Use
<b>A</b> ALPHA		Military—Divers or friendly explosive ordnance disposal personnel down.  INTERCO—Diver down. Keep well clear at slow speed.	<b>Close Up.</b> Divers or friendly explosive ordnance disposal personnel down. A numeral group following will indicate the radius in hundreds of yards inside which personnel are operating. All vessels are to remain clear.
		<b>Memory aid:</b> Looks like a letter "A" on its side.	
<b>B</b> BRAVO		Military—Fuelling or transferring explosives or inflammable material.  INTERCO—Taking in, discharging or carrying dangerous goods.	<b>At the Dip.</b> Temporarily stopped fuelling or transferring.  <b>Close Up.</b> Fuel, explosives or inflammable material is being transferred.
		<b>Memory aid:</b> Looks like the letter "B". "B" for boom. Red means danger.	
<b>G</b> GOLF		Military—Guide.  INTERCO—I require a pilot.	<b>Close Up.</b> This ship is to be the lead ship, follow me. When G TACK plus CALL SIGN is hoisted, it indicates that the ship denoted by the call sign is to be the lead ship.
		<b>Memory aid:</b> Grass on a golf course. Sand traps and water on a golf course.	
<b>I</b> INDIA		Military—Going alongside (in port or at anchor).  INTERCO—Altering my course to port.	<b>SHIP GOING ALONGSIDE</b>  <b>At the Dip.</b> I am preparing to come alongside you.  <b>Close Up.</b> I am ready to come alongside you.  <b>Hauled Down.</b> First line is secured.
		<b>RECEIVING SHIP</b>  <b>At the Dip.</b> I am preparing to receive you on the side indicated.  <b>Close Up.</b> I am ready to receive you on the side indicated.  <b>Hauled Down.</b> First line is secured.	
<b>Memory aid:</b> When preparing to tie, remember to dot your "i".			

Director Cadets 3, 2008, Ottawa, ON: Department of National Defence





Figure 14-2-1 (Sheet 1 of 3) Common Flags and Pennants

Signal	Example	Meaning	SCTV Use
<b>J</b> JULIETT		Military—Semaphore message.  INTERCO—I am on fire.	<b>Close Up.</b> My vessel is on fire. Keep well clear. The INTERCO meaning is assumed on an Sea Cadet Training Vessel and is used here without hoisting ANS.
		<b>Memory aid:</b> White hot, need lots of water.	
<b>O</b> OSCAR		Military—Man overboard.  INTERCO—Man overboard.	<b>Close Up.</b> Man overboard.
		<b>Memory aid:</b> Yellow and red will flash, after you hear the splash.	
<b>P</b> PAPA		Military—General recall.  INTERCO—Recall. Vessel about to sail.	<b>Close Up.</b> All personnel belonging to this ship must return immediately.
		<b>Memory aid:</b> White on blue, the boat will sail without you.	
<b>Q</b> QUEBEC		Military—Boat recall.  INTERCO—Vessel is healthy. Request free pratique (ability to manoeuvre).	<b>Close Up.</b> All boats belonging to this ship must return immediately.  (Used by vessels entering a foreign port to denote that they are healthy but have not cleared through customs or immigration).
		<b>Memory aid:</b> When flying quebec, all boats back on deck.	
<b>U</b> UNIFORM		Military—Anchoring.  INTERCO—You are running into danger.	<b>At the Dip.</b> Anchor let go, veering cable. <b>Close Up.</b> Cable veered, working cable. <b>Hauled Down.</b> Ship has her anchor.
		Military—Mooring.	<b>At the Dip.</b> Mooring cable let go. <b>Close Up.</b> Cable middled. <b>Hauled down.</b> Cable secured.
		Military—Weighing.	<b>At the Dip.</b> Heaving in anchor cable. <b>Close Up.</b> Anchor aweigh. <b>Hauled Down.</b> I am ready to proceed.
		<b>Memory aid:</b> With the red and white, the anchor takes a bite.	

Director Cadets 3, 2008, Ottawa, ON: Department of National Defence

Figure 14-2-1 (Sheet 2 of 3) Common Flags and Pennants

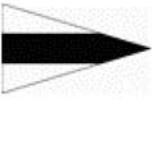

Signal	Example	Meaning	SCTV Use
<b>X</b> X-RAY		Military—Exercising. INTERCO—Stop carrying out your intentions and watch for my signals.	<b>Close Up.</b> Exercises completed. When X TACK (signal) is hoisted, it indicates that the meaning denoted by the signal is being exercised. For simplicity, the tack line may be left out.
<b>Z</b> ZULU		Military—Communication guard. INTERCO—I require a tug.	<b>Close Up.</b> I require a tug (tow). The INTERCO meaning is assumed on an SCTV and is used without hoisting ANS.
<b>5</b> FIVE		Military—Breakdown. INTERCO—Numeral 5.	<b>Close Up.</b> I have a breakdown.
<b>PREPARATIVE</b>		Military—Morning and evening ceremonies/Colours (as appropriate). INTERCO—No meaning.	<b>Close Up.</b> Five minutes until the Ceremony/Colours. <b>At the Dip.</b> Commence Ceremony/Colours. <b>Hauled Down.</b> Ceremony/Colours completed.
<b>3<sup>rd</sup></b> SUBSTITUTE		Military—Absentee indicator (CO/XO) (used in port only). INTERCO—Substitute the third flag in this hoist for this flag.	<b>Close Up.</b> Absence of the Commanding Officer (CO). Its use immediately shifts to the Executive Officer (XO) when the CO departs for a known period of time in excess of 72 hours.

*Director Cadets 3, 2008, Ottawa, ON: Department of National Defence*

Figure 14-2-1 (Sheet 3 of 3) Common Flags and Pennants

### ACTIVITY

Time: 20 min

### OBJECTIVE

The objective of this activity is to have the cadets practice flag recognition skills.

## RESOURCES

- Flag flash cards located at Annex F (five sets),
- Flash card results sheet located at Annex G (one per cadet), and
- Five small tables.

## ACTIVITY LAYOUT



This activity can be scaled down to accommodate a smaller class size by setting up fewer stations.

1. Set up tables in an area large enough to accommodate all of the cadets (as illustrated in Figure 14-2-2).

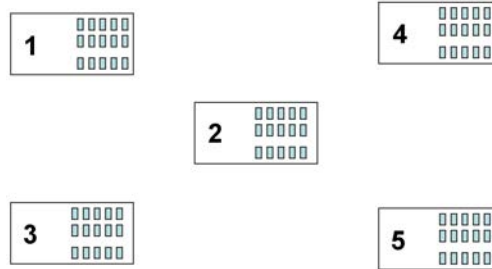

*Director Cadets 3, 2007, Ottawa, ON: Department of National Defence*

Figure 14-2-2 Layout for Flag Flash Card Activity

2. Lay a set of flag flash cards face down on each table.

## ACTIVITY INSTRUCTIONS

1. Brief the cadets on the rules of the activity, to include:
  - (a) No talking unless asking a question.
  - (b) No signalling to other players.
  - (c) Questions must have yes or no answers.
  - (d) Questions must be asked to one other cadet only.
  - (e) Only one question or guess per turn.
  - (f) Cards must be visible to other players at all times.
2. Divide the cadets into five equal groups, not to exceed 10 cadets per group.
3. Have each group stand around a table.
4. Select a cadet from each table that will start the round.
5. Give each cadet a results sheet.
6. On the word “Go”, all cadets will pick up a card from the table without looking at it and hold it on the forehead with one finger.

7. The cadet designated to start the round will ask one other cadet in the group a question about the card they hold.
8. Play continues with the cadet on the right, who may ask a question or guess at the card they hold.
9. If a cadet's guess is incorrect, they will place the card face down on the table and pick up another card. If the cadet's guess is correct, they will place the card face down on the table and record a check mark on the results sheet. That cadet will proceed to another table, pick up another card and continue playing. Play at the previous table will continue with the cadet on the right of the space just vacated.
10. The activity continues around the tables until all cadets have five check marks.

### SAFETY

N/A.

---

### CONFIRMATION OF TEACHING POINT 3

---

The cadets' participation in the activity will serve as the confirmation of this TP.

---

### Teaching Point 4

### Identify the Parts of a Signal Mast

Time: 5 min

Method: Interactive Lecture

---

### PARTS OF A SIGNAL MAST



Distribute the signal mast handout located at Annex H to the cadets.

Identify the parts on an actual signal mast (as illustrated in Figure 14-2-3). If a signal mast is not available, identify the parts using the signal mast handout located at Annex H.

**Mast.** A long, upright pole erected on a vessel or shore.

**Masthead (Truck).** Top portion of a mast.

**Yard.** The horizontal spars fitted on a mast to carry sails, rigging or signals.

**Gaff.** A spar projecting aft from the mast and angled up at approximately 45 degrees.

**Halyard.** The line which raises or lowers a signal flag.

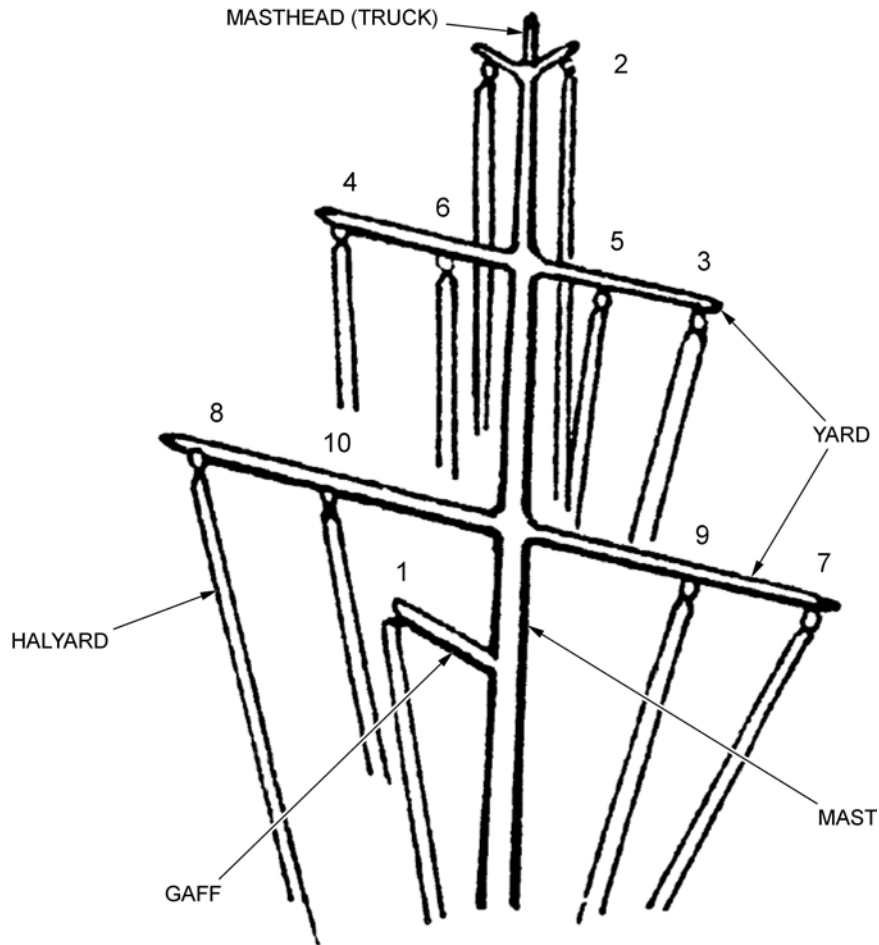

*Chief of Maritime Staff/Staff Officer Heritage, Manual of Ceremony for HMC Ships, Submarines and Naval Reserve Divisions, Department of National Defence (p. 2A-3)*

Figure 14-2-3 Parts of a Signal Mast and Superior Positions

---

#### CONFIRMATION OF TEACHING POINT 4

---

#### QUESTIONS

- Q1. What is the top of the mast called?
- Q2. What are the horizontal spars on a mast called?
- Q3. What is a halyard used for?

#### ANTICIPATED ANSWERS

- A1. Masthead (truck).
- A2. Yards.
- A3. To raise or lower a signal flag.

**Teaching Point 5****Identify the Superior Positions on a Signal Mast**

Time: 5 min

Method: Interactive Lecture

**SUPERIOR POSITIONS**

Identify the superior positions on an actual signal mast (as illustrated in Figure 14-2-3). If a signal mast is not available, identify the positions using the signal mast handout located at Annex H.

Flags of a single hoist are to be read from the top down and adjacent hoists are to be read from the outboard to inboard or from forward to aft. When two flag hoists are flying simultaneously, the one to be read first is said to be in a “superior” position. Conversely, a flag hoist which is to be read after another is referred to as being in an “inferior” position.

On a signal mast, the superior position is the gaff, if fitted, followed by the masthead (truck). On a yard, the signals are read from the outer halyards first and then the inner halyards starting with the starboard side (as illustrated in Figure 14-2-3).

**CONFIRMATION OF TEACHING POINT 5****QUESTIONS**

- Q1. What position on a signal mast is superior to the masthead (truck) position?
- Q2. Which side of a yard is the superior side?
- Q3. What does it mean when a signal is in a superior position?

**ANTICIPATED ANSWERS**

- A1. The gaff position, if fitted.
- A2. Starboard side.
- A3. It is to be read before other signals.

**Teaching Point 6****Conduct Activities Where the Cadets Will Communicate Using Flags And Pennants**

Time: 50 min

Method: In-Class Activity



The activities in this TP offer the cadets the opportunity to practice signal hoist skills previously learned in this lesson.

---

## ACTIVITY 1

---

Time: 30 min

---

### OBJECTIVE

The objective of this activity is to have the cadets practice signal hoist skills.

### RESOURCES

- Flags and pennants (two sets), to include:
  - alpha,
  - bravo,
  - golf,
  - india,
  - juliet,
  - oscar,
  - papa,
  - quebec,
  - uniform,
  - x-ray,
  - zulu,
  - flag '5',
  - preparative, and
  - 3<sup>rd</sup> substitute;
- One-metre tack lines (two),
- Signal masts or halyards (two),
- Signal hoist cue cards located at Annex I (two sets),
- Signal hoist results sheet located at Annex J (two), and
- Signal hoist answer key located at Annex K (two).

### ACTIVITY LAYOUT

The instructor will set up two tables beside the signal masts with one set of cue cards on each table (as illustrated in Figure 14-2-4).

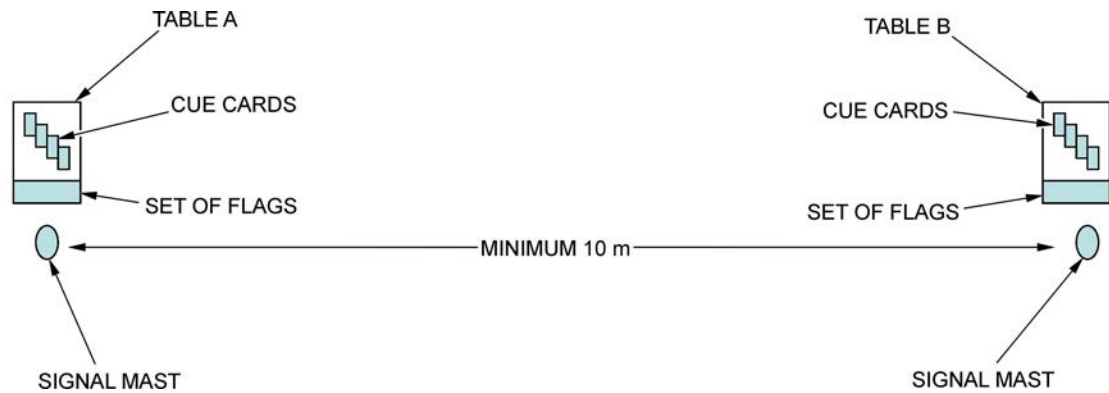

*Director Cadets 3, 2007, Ottawa, ON: Department of National Defence*

Figure 14-2-4 Layout for Flag Hoist Activity

### ACTIVITY INSTRUCTIONS

1. Brief the cadets on the rules of the activity, to include:
  - (a) Each cadet has 30 seconds to complete the hoist as indicated on the cue card before the team can assist.
  - (b) Each team has 30 seconds from the time the cadet requests assistance to complete the hoist as indicated on the cue card.
  - (c) Ten points are awarded for a correct, unassisted hoist.
  - (d) Five points are awarded for a correct, team-assisted hoist.
  - (e) Ten points are awarded for a correctly decoded signal.
  - (f) No discussion is allowed until assistance is requested.
2. Divide the cadets into two equal groups.
3. Decide which team will go first.
4. One cadet from the team will select a cue card and proceed to hoist the signals as indicated on the card. If they are unsure as to the correct hoist, they may ask another cadet on the team for assistance in hoisting the correct signal.
5. The opposite team will decode the signal and record the results on the results sheet.
6. Teams will alternate sending and receiving until all cadets have had a turn hoisting a signal.
7. Debrief the cadets on the results before continuing on to the next activity.

### SAFETY

N/A.

---

### ACTIVITY 2

Time: 20 min

---

### OBJECTIVE

The objective of this activity is to have the cadets practice signal flag recognition skills.

## RESOURCES

- Flags and pennants, to include:
  - alpha,
  - bravo,
  - golf,
  - india,
  - juliet,
  - oscar,
  - papa,
  - quebec,
  - uniform,
  - x-ray,
  - zulu,
  - flag '5',
  - preparative, and
  - 3<sup>rd</sup> substitute; and
- Large sack/bag.

## ACTIVITY LAYOUT

The instructor will place all the flags and pennants in the large sack.

## ACTIVITY INSTRUCTIONS

1. Brief the cadets on the rules of the activity, to include:
  - (a) Pick only one flag from the sack.
  - (b) Each cadet has 15 seconds to identify the flag.
  - (c) The cadets will continue the activity until they correctly identify a picked flag.
2. Have the cadets line up in three lines around the sack.
3. Each cadet reaches into the sack, picks one flag and identifies which flag it is.
4. The flag is placed back into the bag.
5. The activity will continue until all cadets have picked a flag and correctly identified it.
6. Debrief the cadets on the results observed in the activity.

## SAFETY

N/A.



---

### CONFIRMATION OF TEACHING POINT 6

---

The cadets' participation in the activities will serve as the confirmation of this TP.

---

### END OF LESSON CONFIRMATION

---

The cadets' participation in the activities in TP 6 will serve as the confirmation of this lesson.

---

### CONCLUSION

---

#### HOMework/READING/PRACTICE

N/A.

#### METHOD OF EVALUATION

N/A.

#### CLOSING STATEMENT

Flags and pennants are used extensively in the nautical environment as a means of visually communicating information to the vessel's crew, shore stations and other ships that are in sight. It is important to understand how to communicate using flags and pennants as the cadets may be required to receive signals from a vessel which could indicate distress or urgent situations at a sail centre or on-water weekend.

#### INSTRUCTOR NOTES/REMARKS

This lesson may be taught in four periods during a weekend training day or four periods over two training nights consisting of TPs 1–4 on the first night and TPs 5 and 6 on the second night.

If time permits, the cadets can qualify for the *Sea Cadet Flag and Pennant Certificate*. This can be achieved by identifying and describing the meaning of all flags and pennants used by the Canadian Navy with an accuracy of 80 percent and reciting the phonetic alphabet with an accuracy of 90 percent. Remaining flags and pennants can be found in reference A1-020 (pp. 2-1 to 2-12).

---

### REFERENCES

---

- |        |   |
|--------|---|
| A1-002 | Chief of Maritime Staff/Staff Officer Heritage. (2004). <i>Manual of Ceremony for HMC Ships, Submarines and Naval Reserve Divisions</i> . Ottawa, ON: Department of National Defence.                                   |
| A1-004 | B-GN-181-105/FP-E00 Chief of the Maritime Staff. (2000). <i>CFCD 105 Fleet Seamanship Rigging and Procedures Manual</i> . Ottawa, ON: Department of National Defence.   |
| A1-020 | North American Treaty Organization. (2003). MTP 1(D), <i>Multinational Maritime Tactical Signal and Manoeuvring Book</i> (Vol. 2). Washington, DC: Custodian North American Treaty Organization Standardization Agency. |

THIS PAGE INTENTIONALLY LEFT BLANK



**ROYAL CANADIAN SEA CADETS**  
**PHASE THREE**  
**INSTRUCTIONAL GUIDE**



**SECTION 3**  
**EO C323.02 – PIPE WAKEY WAKEY**

---

Total Time: 60 min

---



---

**PREPARATION**

---

**PRE-LESSON INSTRUCTIONS**

Resources needed for the delivery of this lesson are listed in the lesson specification located in A-CR-CCP-603/PG-001, Chapter 4. Specific uses for said resources are identified throughout the instructional guide within the TP for which they are required.

Review the lesson content and become familiar with the material prior to delivering the lesson.

Photocopy the Wakey Wakey diagram located at Annex L for each cadet. Ensure a sufficient number of boatswain's calls are available for the class. If there is not one per cadet, ensure cleaning solution is available to disinfect the boatswain's calls after each use.

**PRE-LESSON ASSIGNMENT**

N/A.

**APPROACH**

An interactive lecture was chosen for TP 1 to introduce piping Wakey Wakey and to provide an overview of its purpose.

Demonstration and performance was chosen for TP 2 as it allows the instructor to demonstrate piping Wakey Wakey while providing an opportunity for the cadets to practice making the pipe under supervision.

---

**INTRODUCTION**

---

**REVIEW**

N/A.

**OBJECTIVES**

By the end of this lesson the cadet shall have piped Wakey Wakey.

**IMPORTANCE**

The boatswain's call is used as a naval form of communication. It is important for the cadets to know how to respond to Wakey Wakey and to execute the notes required using the boatswain's call.

---

**Teaching Point 1****Explain the Purpose of Wakey Wakey**

Time: 5 min

Method: Interactive Lecture

---

**WAKEY WAKEY**

Wakey Wakey is used to wake the Ship's Company in the morning. In the hours between Pipe Down and Wakey Wakey, pipes should only be made in emergency situations.

---

**CONFIRMATION OF TEACHING POINT 1**

---

**QUESTIONS**

Q1. What is the purpose of Wakey Wakey?

Q2. In the hours between Pipe Down and Wakey Wakey, when should pipes be made?

**ANTICIPATED ANSWERS**

A1. To wake the Ship's Company in the morning.

A2. Only in an emergency situation.

---

**Teaching Point 2****Demonstrate and Have the Cadets Practice Piping Wakey Wakey**

Time: 45 min

Method: Demonstration and Performance

---

**WAKEY WAKEY**

Audio samples of Wakey Wakey can be found at [http://www.navy.forces.gc.ca/cms\\_youth/youth\\_articles\\_e.asp?id=506](http://www.navy.forces.gc.ca/cms_youth/youth_articles_e.asp?id=506).



Distribute the Wakey Wakey diagram located at Annex L to each cadet.

Wakey Wakey is a 21-second pipe made as follows:

1. The low note is produced sharply ascending to the high note at one second. This is followed by nine short blasts of the high note that last three seconds, the first four blasts being slightly longer than the next five.
2. At four seconds the high note is produced for one second which sharply descends to the low note for one second.
3. At six seconds there is a sharp break. The high note is then produced for one second which sharply descends to the low note for one second. This is followed by a quick break.

4. At 10 seconds, the low note is produced sharply ascending to the high note with a sharp finish. This is followed by nine short blasts of the high note that last three seconds, the first four blasts being slightly longer than the next five.
5. At 13 seconds the high note is produced for one second which sharply descends to the low note for one second.
6. At 15 seconds there is a quick break. The high note is then produced for one second which sharply descends to the low note for one second. This is followed by a sharp break.
7. At 18 seconds the low note is produced with a sharp ascent to the high note, followed by a sharp break.
8. At 19 seconds the low note is produced, sharply ascending to the high note for one second, then sharply descending to the low note with a sharp finish at 21 seconds.



Pass out the boatswain's calls at this point and explain to the cadets that they are only to be used when instructed.



Placing the teeth on the ridges at the mouth of the boatswain's call will assist in controlling the pipes as the tongue can be used to stop the air flow. This will help to keep the notes sharp.

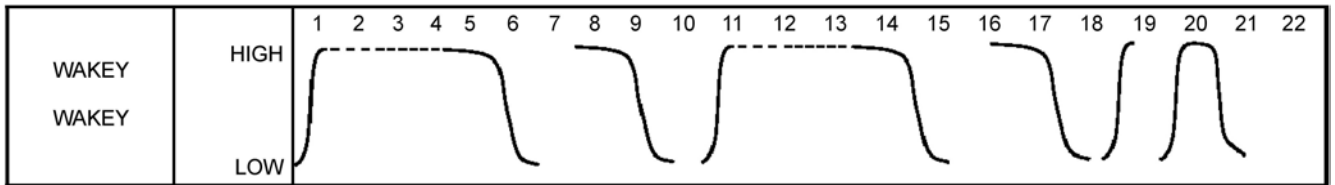

*Director Cadets 3, 2007, Ottawa, ON: Department of National Defence*

Figure 14-3-1 Wakey Wakey



Demonstrate and have the cadets practice piping Wakey Wakey.

---

**CONFIRMATION OF TEACHING POINT 2**

---

The cadets' practicing piping Wakey Wakey will serve as the confirmation of this TP.

---

**END OF LESSON CONFIRMATION**

---

The cadets' piping Wakey Wakey will serve as the confirmation of this lesson.

---

## CONCLUSION

---

### HOMEWORK/READING/PRACTICE

N/A.

### METHOD OF EVALUATION

N/A.

### CLOSING STATEMENT

Sounding pipes on the boatswain's call is a tradition that has been maintained for hundreds of years. Using pipes to deliver orders is a large part of what makes naval institutions unique. It is important to know how to respond to the various pipes and to execute notes using the boatswain's call in order to serve in a naval environment.

### INSTRUCTOR NOTES/REMARKS

Instructors can find audio samples of Wakey Wakey at reference A1-022 which may be played for the cadets during this lesson.

Ensure the boatswain's calls are cleaned with a cleaning solution between uses.

---

## REFERENCES

---

- A1-022 Canadian Navy. (2006). *Youth Section—Pipe Sounds*. Retrieved February 28, 2007, from [http://www.navy.forces.gc.ca/cms\\_youth/youth\\_articles\\_e.asp?id=506](http://www.navy.forces.gc.ca/cms_youth/youth_articles_e.asp?id=506).



## ROYAL CANADIAN SEA CADETS

### PHASE THREE

### INSTRUCTIONAL GUIDE



### SECTION 4

### EO C323.03 – PIPE HANDS TO DINNER

Total Time:

90 min

### PREPARATION

#### PRE-LESSON INSTRUCTIONS

Resources needed for the delivery of this lesson are listed in the lesson specification located in A-CR-CCP-603/PG-001, Chapter 4. Specific uses for said resources are identified throughout the instructional guide within the TP for which they are required.

Review the lesson content and become familiar with the material prior to delivering the lesson.

Photocopy the Hands to Dinner diagram located at Annex M for each cadet. Ensure a sufficient number of boatswain's calls are available for the class. If there is not one per cadet, ensure cleaning solution is available to disinfect the boatswain's calls after each use.

#### PRE-LESSON ASSIGNMENT

N/A.

#### APPROACH

An interactive lecture was chosen for TP 1 to introduce piping Hands to Dinner and to provide an overview of its purpose.

Demonstration and performance was chosen for TPs 2 and 3 as it allows the instructor to demonstrate the warble, the trill and Hands to Dinner while providing an opportunity for the cadets to practice making the pipe under supervision.

### INTRODUCTION

#### REVIEW

N/A.

#### OBJECTIVES

By the end of this lesson the cadet shall have piped Hands to Dinner.

#### IMPORTANCE

The boatswain's call is used as a naval form of communication. It is important for the cadets to know how to respond to Hands to Dinner and to execute the notes required using the boatswain's call.

**Teaching Point 1****Explain the Purpose of Hands to Dinner**

Time: 5 min

Method: Interactive Lecture

**HANDS TO DINNER**

Hands to Dinner is piped at noon when the Ship's Company secures and commences the mid-day meal. The pipe is an order itself and does not require any verbal addition. At noon, when the pipe is made, the galley is open for the general population of the ship's company. Prior to this, at 1115 hours, the General Call is piped and the announcement is made for the afternoon watch to eat.

Noon hour is the only time Hands to Dinner is piped. At breakfast and supper an announcement is made for hands to breakfast/supper respectively following a General Call.

**CONFIRMATION OF TEACHING POINT 1****QUESTIONS**

- Q1. When is Hands to Dinner piped?  
 Q2. What is the purpose of the pipe?  
 Q3. Are any verbal orders necessary to follow the pipe?

**ANTICIPATED ANSWERS**

- A1. Noon.  
 A2. For the Ship's Company to secure and commence the mid-day meal.  
 A3. No, the pipe is an order itself.

**Teaching Point 2****Demonstrate and Have the Cadets Practice Tones**

Time: 20 min

Method: Demonstration and Performance

**TONES**

There are three tones used when making pipes. The tones are plain (which was taught in Phase Two of the corps program), the warble and the trill.



Pass out the boatswain's calls at this point and explain to the cadets that they are only to be used when instructed.



Placing the teeth on the ridges at the mouth of the boatswain's call will assist in controlling the pipes as the tongue can be used to stop the air flow. This will help keep the notes sharp.

**Warble.** Produced by repeatedly moving the hand quickly from the high to the low position.





It results in a warble sound similar to that of a canary.

**Trill.** Produced by vibrating the tongue while blowing into the pipe, as in rolling the letter 'R'.



Demonstrate and have the cadets practice the warble and the trill.

## CONFIRMATION OF TEACHING POINT 2

The cadets' practicing the warble and the trill will serve as the confirmation of this TP.

### Teaching Point 3

### Demonstrate and Have the Cadets Practice Piping Hands to Dinner

Time: 55 min

Method: Demonstration and Performance



Hands to Dinner is a difficult pipe to make. The cadets are expected to be given an opportunity to practice this pipe, not to become proficient at it, during this lesson.

### HANDS TO DINNER



Audio samples of Hands to Dinner can be found at [http://www.navy.forces.gc.ca/cms\\_youth/youth\\_articles\\_e.asp?id=506](http://www.navy.forces.gc.ca/cms_youth/youth_articles_e.asp?id=506).



Distribute the Hands to Dinner diagram located at Annex M to each cadet.

Hands to Dinner is a 30-second pipe made as follows:

1. The low note is produced and gradually ascends to the high note at five seconds, then gradually descends back to the low note at eight seconds.
2. At eight seconds there is a sharp break. The low note is then produced, ascending sharply to the high note at 11 seconds and descending gradually to the low note with a sharp finish at 15 seconds.
3. Two sharp blasts of the low note follow, then the low note ascends sharply to the high note for one second and back to the low note at 20 seconds.

4. This is followed by a five second warble which cuts off on the low note at 25 seconds.
5. Two sharp blasts of the high note are then produced followed by a trill that starts at the high note and gradually descends to the low note with a slight ascent toward the high note and a sharp finish at 30 seconds.

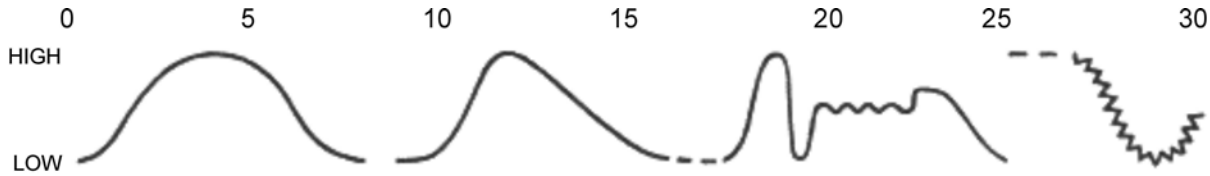

*Royal Navy, Admiralty Manual of Seamanship 1964 (Vol. 1), Her Majesty's Stationery Office (p. 340)*

Figure 14-4-1 Hands to Dinner



Demonstrate and have the cadets practice piping Hands to Dinner.

As this pipe is 30 seconds long, it will take a lot of practice and may be easier to teach in steps as broken out above before practicing the entire pipe.

---

### CONFIRMATION OF TEACHING POINT 3

---

The cadets' practicing piping Hands to Dinner will serve as the confirmation of this TP.

---

### END OF LESSON CONFIRMATION

---

The cadets' piping the warble, the trill and Hands to Dinner will serve as the confirmation of this lesson.

---

### CONCLUSION

---

### HOMEWORK/READING/PRACTICE

N/A.

### METHOD OF EVALUATION

N/A.

### CLOSING STATEMENT

Sounding pipes on the boatswain's call is a tradition that has been maintained for hundreds of years. Using pipes to deliver orders is a large part of what makes naval institutions unique. It is important to know how to respond to the various pipes and execute notes using the boatswain's call in order to serve in a naval environment.

### INSTRUCTOR NOTES/REMARKS

Instructors can find audio samples of Hands to Dinner at reference A1-022 that may be played for the cadets during this lesson.

Ensure the boatswain's calls are cleaned with a cleaning solution between uses.

---

**REFERENCES**

---

- A1-022 Canadian Navy. (2006). *Youth Section—Pipe Sounds*. Retrieved February 29, 2007, from [http://www.navy.forces.gc.ca/cms\\_youth/youth\\_articles\\_e.asp?id=506](http://www.navy.forces.gc.ca/cms_youth/youth_articles_e.asp?id=506).
- C1-003 (ISBN 11-770973-5) Royal Navy. (1972). *Admiralty Manual of Seamanship 1964* (Vol. 1). London, England: Her Majesty's Stationery Office.
- C1-043 Ready Aye Ready. (n.d.). *The Boatswain's Call*. Retrieved February 19, 2007, from <http://www.readyayeready.com/navy-life/boatswains-call.htm>.

THIS PAGE INTENTIONALLY LEFT BLANK

### FUNCTIONAL ORGANIZATION

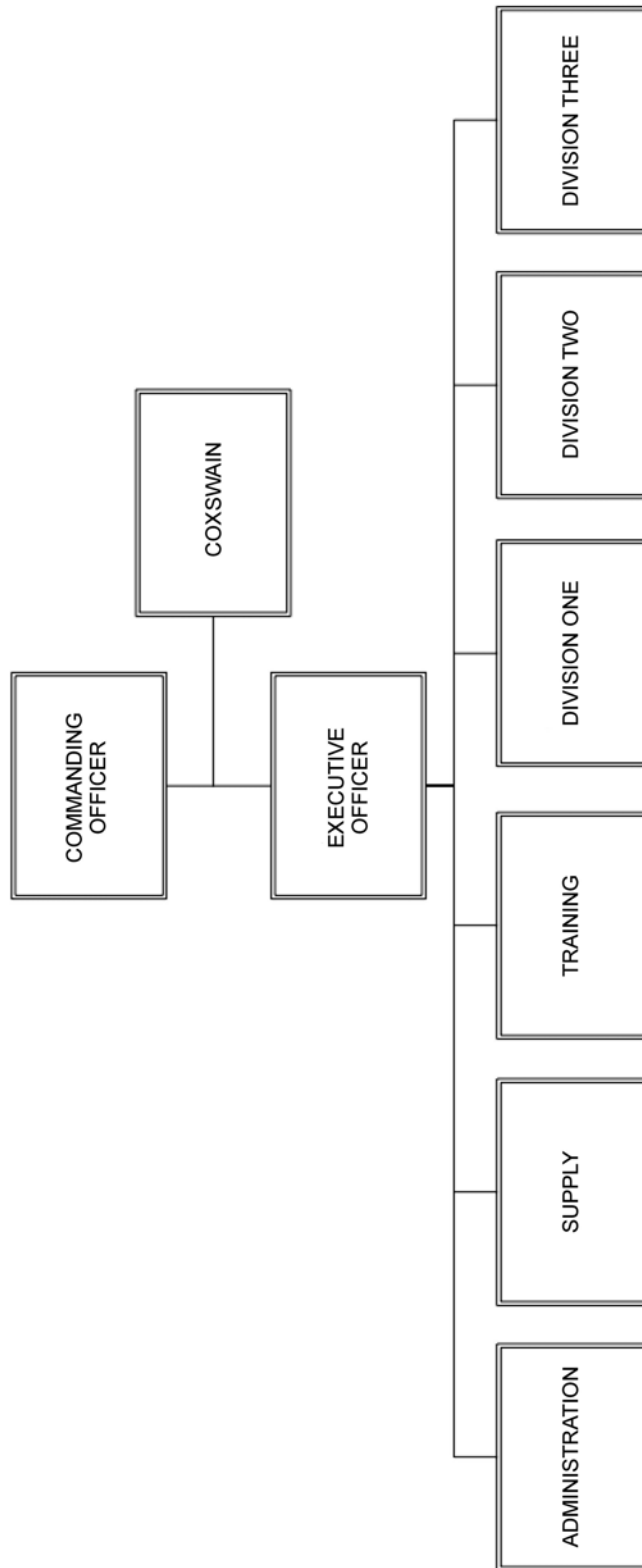

*Director Cadets 3, 2008, Ottawa, ON: Department of National Defence*

Figure 14A-1 Functional Organization

THIS PAGE INTENTIONALLY LEFT BLANK

### DUTY PERSONNEL ORGANIZATION

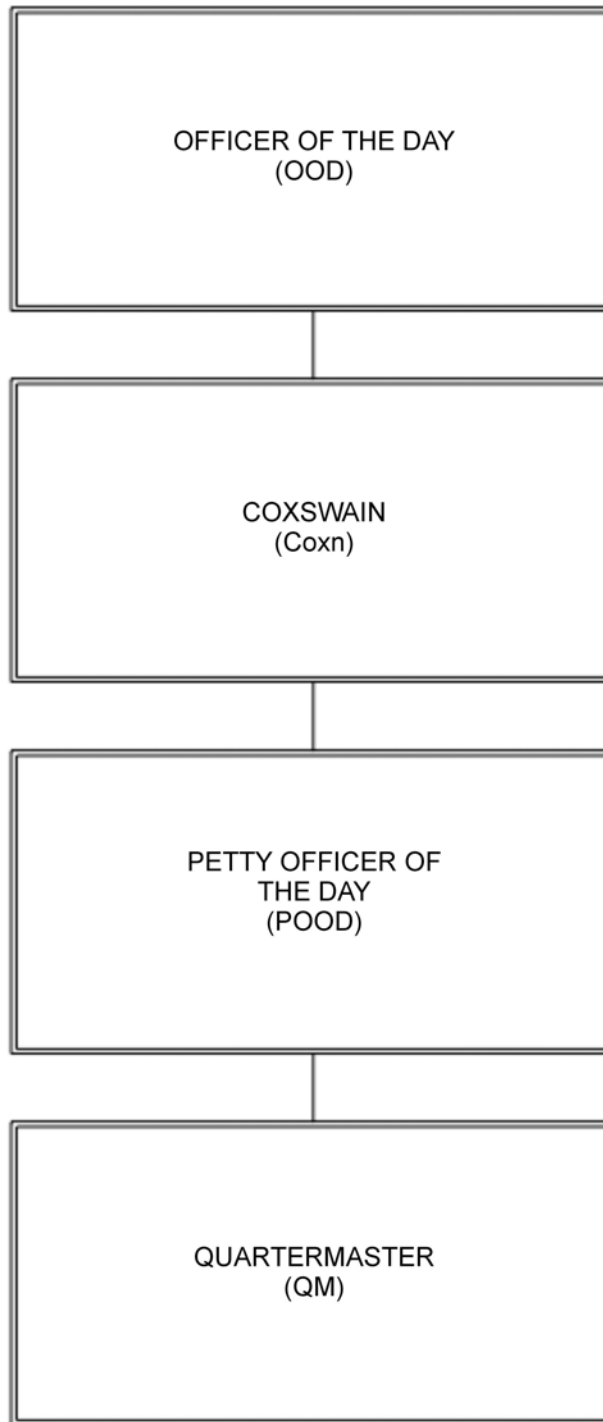

*Director Cadets 3, 2008, Ottawa, ON: Department of National Defence*

Figure 14B-1 Duty Personnel Organization

THIS PAGE INTENTIONALLY LEFT BLANK



### TRAINING ORGANIZATIONS

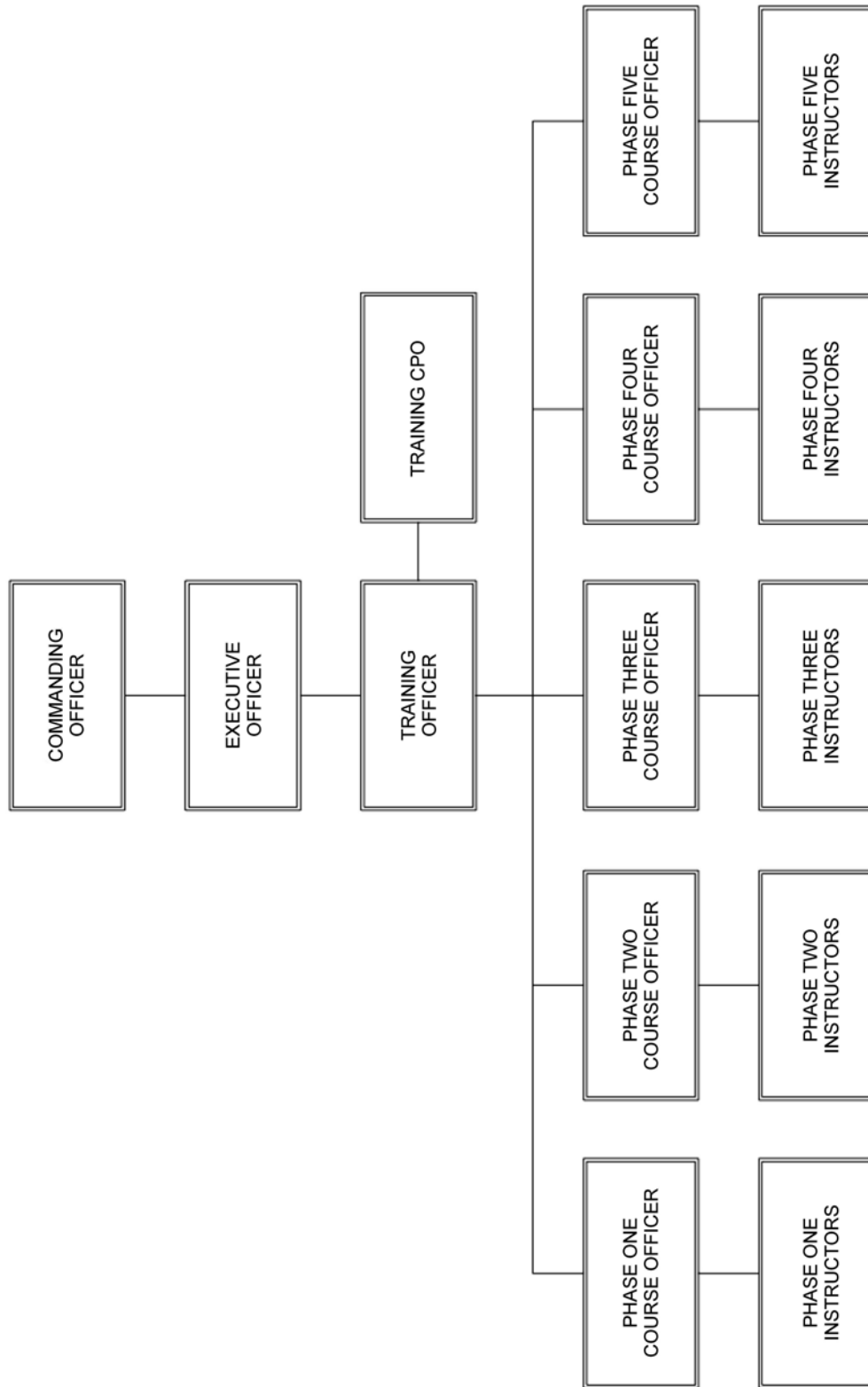

Director Cadets 3, 2008, Ottawa, ON: Department of National Defence

Figure 14C-1 Training Organization – Option One

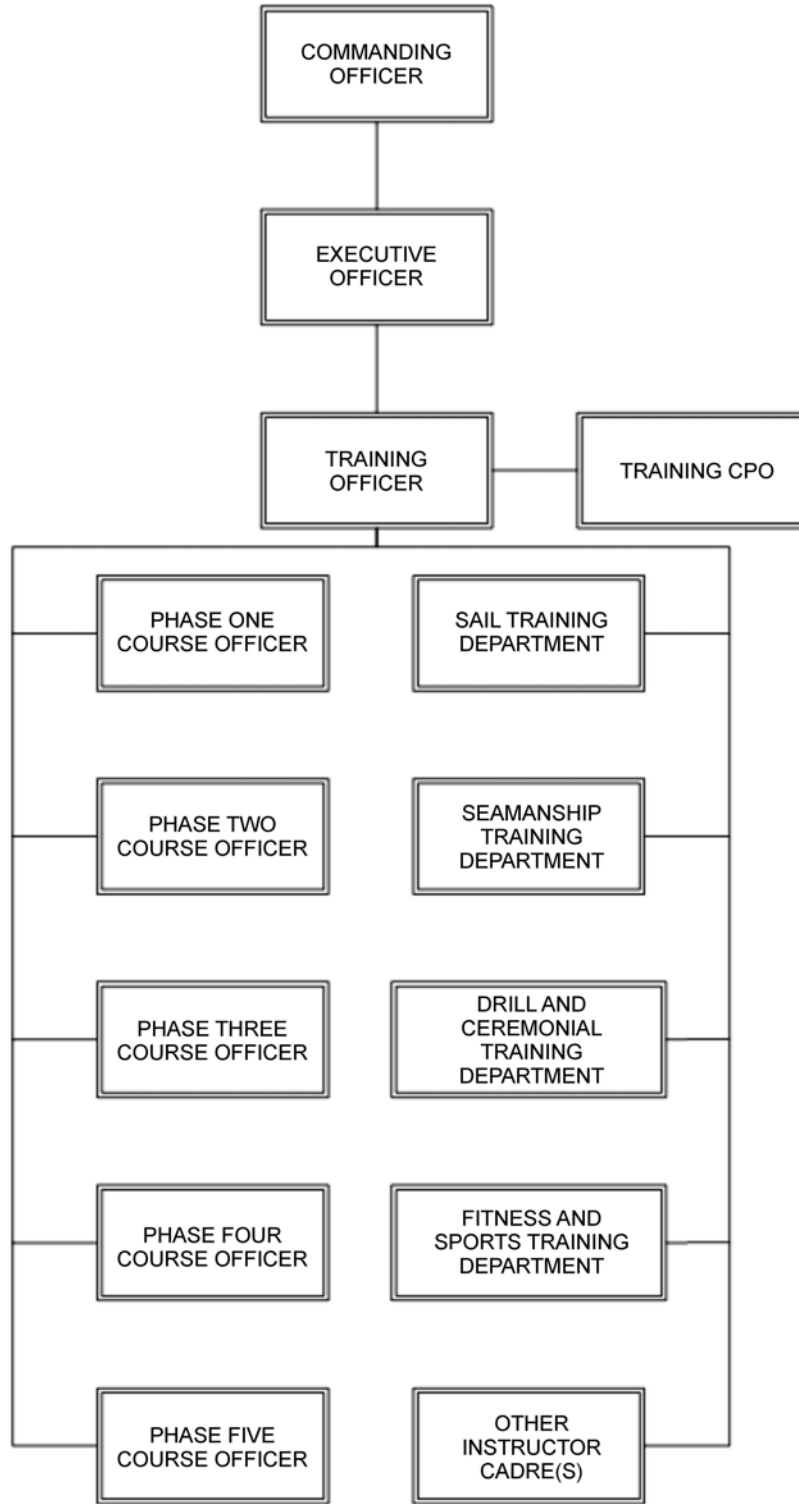

*Director Cadets 3, 2008, Ottawa, ON: Department of National Defence*

Figure 14C-2 Training Organization – Option Two

## QUATERMASTER TERMS OF REFERENCE

<b>Position:</b>	Quartermaster.
<b>Short Title:</b>	QM.
<b>Established Rank:</b>	Leading Seaman/Master Seaman.
<b>Responsible to:</b>	Petty Officer of the Day.
<b>Responsible for:</b>	The QM shall stand duty in the immediate vicinity of the brow (main entrance). The QM shall not leave the area except to carry out other Quartermaster duties, attend classes or in the case of an emergency when they will inform the OOD of their action.
<b>Primary Duties:</b>	The QM is responsible to the POOD. Normally they will exercise this responsibility through the POOD or Coxn, but should not hesitate to report directly to the OOD when it is considered necessary. If a report is made to the OOD, the QM shall inform the POOD as soon as possible.

The Quartermaster is specifically responsible for:

- running colours and sunset, to include:
  - organizing the flag party;
  - piping the still; and
  - piping the carry on;
- maintaining the corps' routine and controlling of the corps' broadcast system, to include:
  - ringing the ship's bell; and
  - making pipes or using the corps' broadcast system;
- controlling the brow, to include:
  - identifying all personnel coming aboard or leaving the ship (training location);
  - ensuring that no unauthorized material is taken ashore; and
  - controlling the log; and
- ensuring the cleanliness of the brow area.

**Secondary Duties:** As assigned by the OOD and the Commanding Officer.

THIS PAGE INTENTIONALLY LEFT BLANK

## QUARTERMASTER REFERENCE GUIDE

### PAYING COMPLIMENTS

#### Addressing Cadet NCOs and Subordinate Officers

When addressing a cadet NCO or a subordinate officer, the cadet will stand at the position of attention.

#### Addressing Commissioned Officers

When addressing commissioned officers, the same procedures are followed as when addressing NCOs and subordinate officers except a salute shall be given.

The cadet shall stand at the position of attention after approaching the commissioned officer. The cadet will then give the salute.

### THE 24-HOUR CLOCK

The 24-hour clock uses the numbers 0–24. To convert conventional time into 24-hour time in the pm, simply add 12 to the conventional time. For example, if it is 7:00 pm, add 12 (7+12), which equals 19, therefore it is 1900 hours.

Conventional Time	24-Hour Time	Conventional Time	24-Hour Time
12:00 am	0000	12:00 pm	1200
1:00 am	0100	1:00 pm	1300
2:00 am	0200	2:00 pm	1400
3:00 am	0300	3:00 pm	1500
4:00 am	0400	4:00 pm	1600
5:00 am	0500	5:00 pm	1700
6:00 am	0600	6:00 pm	1800
7:00 am	0700	7:00 pm	1900
8:00 am	0800	8:00 pm	2000
9:00 am	0900	9:00 pm	2100
10:00 am	1000	10:00 pm	2200
11:00 am	1100	11:00 pm	2300

### HOW TO RING THE SHIP'S BELL

The bell is rung with two strokes of the clapper in quick succession, followed by a one-second pause between rings. For example, five bells will sound “ding-ding”, pause, “ding-ding”, pause, “ding”. This is done to make it easier to count the number.

On the hour, the bells are rung in even numbers; on the half hour the bells are rung in odd numbers as follows

- eight bells at 0800 hours;
- one bell at 0830 hours;
- two bells at 0900 hours;
- three bells at 0930 hours;
- four bells at 1000 hours;
- five bells at 1030 hours;
- six bells at 1100 hours;
- seven bells at 1130 hours; and
- eight bells at 1200 hours at which point the cycle repeats itself.

### THE GENERAL CALL

The General Call is produced by blowing the pipe for one second with a short blast of a low to high note, followed by a short pause. A low note is then piped for a half-second with a sharp accent to a high note, lasting for two seconds, followed by a sharp descent to a low note for a half-second. The pipe lasts a total of four seconds.

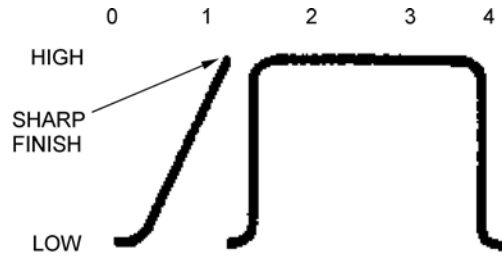

*Royal Navy, Admiralty Manual of Seamanship 1964 (Vol. 1), Her Majesty's Stationery Office (p. 340)*

Figure 14E-1 The General Call

### THE STILL

The Still is produced by holding the high note for eight seconds with a sharp finish.



*Royal Navy, Admiralty Manual of Seamanship 1964 (Vol. 1), Her Majesty's Stationery Office (p. 340)*

Figure 14E-2 The Still

### THE CARRY ON

The Carry On is produced by blowing a high note for one second, followed by a sharp descent to a one second low note with a sharp finish. The Carry On lasts a total of two seconds.

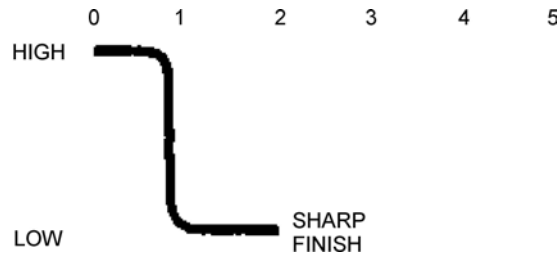

*Royal Navy, Admiralty Manual of Seamanship 1964 (Vol. 1), Her Majesty's Stationery Office (p. 340)*

Figure 14E-3 The Carry On

FLAG FLASH CARDS

 <b>INDIA</b>	 <b>QUEBEC</b>
 <b>GOLF</b>	 <b>PAPA</b>
 <b>BRAVO</b>	 <b>OSCAR</b>
 <b>ALPHA</b>	 <b>JULIETT</b>

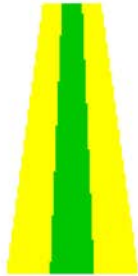
 <p><b>ZULU</b></p>	 <p><b>3<sup>rd</sup> SUBSTITUTE</b></p>
 <p><b>X-RAY</b></p>	 <p><b>PREPARATIVE</b></p>
 <p><b>UNIFORM</b></p>	 <p><b>5</b></p>



**FLAG FLASH CARDS RESULTS SHEET**

<b>NAME:</b>				

<b>NAME:</b>				

<b>NAME:</b>				

<b>NAME:</b>				

<b>NAME:</b>				

(Cut out and distribute one per cadet)

THIS PAGE INTENTIONALLY LEFT BLANK

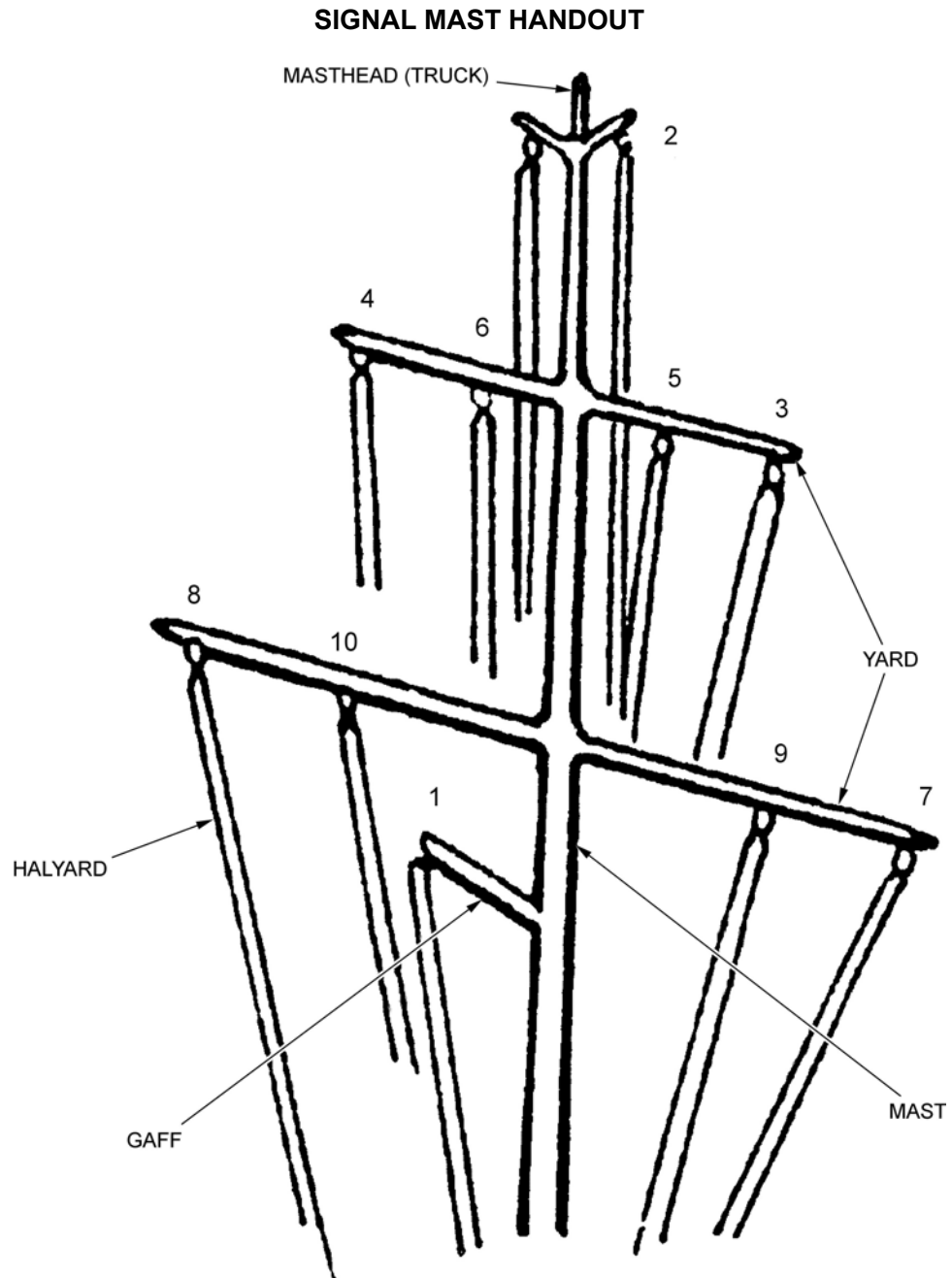

*Chief of Maritime Staff/Staff Officer Heritage, Manual of Ceremony for HMC Ships, Submarines and Naval Reserve Divisions, Department of National Defence (p. 2A-3)*

Figure 14H-1 Parts of a Signal Mast and Superior Positions

THIS PAGE INTENTIONALLY LEFT BLANK

SIGNAL HOIST CUE CARDS

**1**

**I am on fire.**

**2**

**The engineer fell in the  
water.**

**3**

**My divers are within  
200 yards of my ship.**

**4**

**Time to fuel up.**

**5**

**I'm preparing to receive you  
on my starboard side.**

**6**

**I'll take the lead.**

**7**

**Everybody back to the ship.**

**8**

**Anchor let go.**

**9**

**Tow me.**

**10**

**Colours, Sir/Ma'am.**

**11**

**Man overboard exercise.**

**12**

**Captain is not on board.**



**13**

**My rudders do not work.**

THIS PAGE INTENTIONALLY LEFT BLANK

**SIGNAL HOIST RESULTS SHEET**

1.	
2.	
3.	
4.	
5.	
6.	
7.	
8.	
9.	
10.	
11.	
12.	
13.	

THIS PAGE INTENTIONALLY LEFT BLANK

SIGNAL HOIST ANSWER KEY

1.	JULIETT
2.	OSCAR
3.	ALPHA TACK TWO
4.	BRAVO
5.	INDIA (at the dip, starboard side)
6.	GOLF
7.	PAPA
8.	UNIFORM (at the dip)
9.	ZULU
10.	PREPARATIVE (at the dip)
11.	X-RAY TACK OSCAR
12.	3 <sup>rd</sup> SUBSTITUTE
13.	5

THIS PAGE INTENTIONALLY LEFT BLANK

### WAKEY WAKEY DIAGRAM

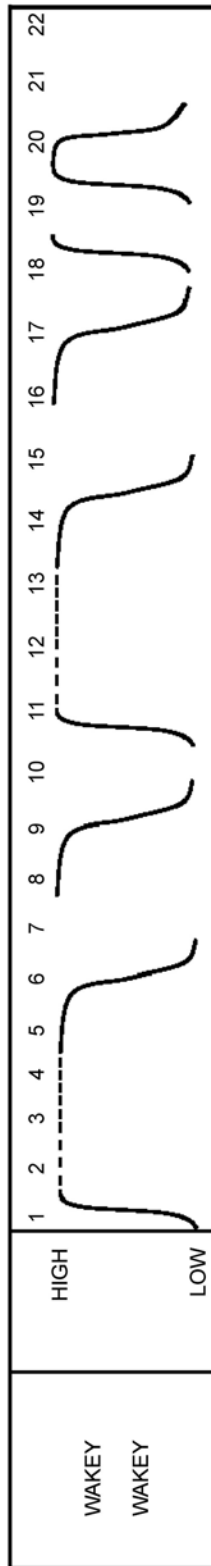

*Director Cadets 3, 2007, Ottawa, ON: Department of National Defence*

Figure 14L-1 Wakey Wakey

THIS PAGE INTENTIONALLY LEFT BLANK



### HANDS TO DINNER DIAGRAM

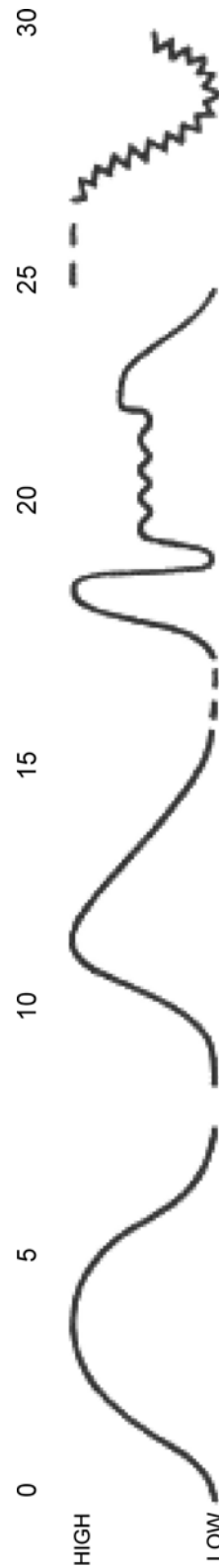

*Royal Navy, Admiralty Manual of Seamanship 1964 (Vol. 1), Her Majesty's Stationery Office (p. 340)*

Figure 14M-1 Hands to Dinner

THIS PAGE INTENTIONALLY LEFT BLANK

**CHAPTER 15**

**PO X24 – SAIL A SAILBOAT IN ACCORDANCE WITH SAIL CANADA CANSAIL LEVEL 1**





**ROYAL CANADIAN SEA CADETS**

**ALL TRAINING LEVELS**

**INSTRUCTIONAL GUIDE  
SAIL**



**PO X24 – SAIL A SAILBOAT IN ACCORDANCE WITH SAIL CANADA CANSAIL LEVEL 1**

---

Total Time:

---

THERE IS NO INSTRUCTIONAL GUIDE PROVIDED FOR THIS EO. REFER TO THE LESSON SPECIFICATION LOCATED IN A-CR-CCP-601/PG-001, *ROYAL CANADIAN SEA CADETS PHASE ONE QUALIFICATION STANDARD AND PLAN*.

THIS PAGE INTENTIONALLY LEFT BLANK

**CHAPTER 16**

**PO X25 – PARTICIPATE IN A NAUTICAL TRAINING WEEKEND**







**ROYAL CANADIAN SEA CADETS**

**ALL TRAINING LEVELS**

**INSTRUCTIONAL GUIDE  
NAUTICAL TRAINING**



**PO X25 – PARTICIPATE IN A NAUTICAL TRAINING WEEKEND**

---

Total Time:

---

THERE IS NO INSTRUCTIONAL GUIDE PROVIDED FOR THIS EO. REFER TO THE LESSON SPECIFICATION LOCATED IN A-CR-CCP-601/PF-001, *ROYAL CANADIAN SEA CADETS PHASE ONE QUALIFICATION STANDARD AND PLAN*.

THIS PAGE INTENTIONALLY LEFT BLANK

**CHAPTER 17**  
**SIDC**





## ROYAL CANADIAN SEA CADETS

### INSTRUCTIONAL GUIDE



## SEAMANSHIP INTERDIVISIONAL COMPETITION

Total Time:

2 days

### PREPARATION

#### PRE-LESSON INSTRUCTIONS

Resources needed for the delivery of this lesson are listed in the lesson specification located in the applicable Qualification Standard and Plan(s). Specific uses for said resources are identified throughout the instructional guide within the TP for which they are required.

Review the lesson content and become familiar with the material prior to delivering the lesson.

Gather and prepare all resources required for the activities listed in this lesson. Setup stations IAW the activities.

Ensure an assistant instructor is available and prepared for each station to act as the Station OPI.

Photocopy as many copies as there are teams (divisions) of Annex A to distribute to the Station OPI's.

Photocopy one copy of Annex B for the Station OPI.

Photocopy, cut out and laminate one copy of the Boatswain's Call Cards located at Annex C.

Photocopy, cut out and laminate one copy of the Task Cards located at Annex D.

Photocopy one copy of Annex E for each team (division).

Photocopy one copy of Annex F for each cadet.

Photocopy, cut out and laminate one copy of the Secret Code Cards for each team (division).

#### PRE-LESSON ASSIGNMENT

N/A.

#### APPROACH

Practical activity was chosen for this lesson as it is an interactive way to allow the cadets to experience seamanship activities in a safe and controlled environment.

### INTRODUCTION

#### REVIEW

N/A.

#### OBJECTIVES

By the end of this lesson the cadet shall be expected to participate in a seamanship interdivisional competition. The objective of the competition is to reinforce the following:

- seamanship knowledge and skills learned throughout the corps training;
- interest in seamanship;
- team-building skills;
- the divisional system; and
- leadership skills through various opportunities for the Phase Three, Four and Five cadets.

### **IMPORTANCE**

It is important for cadets to participate in this competition as it will reinforce many areas of skills and knowledge learned throughout the corps training. It will allow an opportunity for instructors to evaluate the cadets' knowledge and skills. It will provide a further opportunity for team-building for all members of the corps as it reinforces the divisional system and ensures all divisions and corps members work together and interact to meet a common goal. This competition is a great way to relieve boredom, lift team spirit, increase morale, re-energize the cadets and accomplish goals.

---

### **ACTIVITY 1 – COIL AND HEAVE A LINE**

Time: 30 min

---

### **OBJECTIVE**

The objective of this activity is to have the cadets coil and throw a weighted heaving line to a target.

### **RESOURCES**

- Heaving line,
- Target (two),
- Whistle,
- Scoring sheet located at Annex A, and
- Pen/pencil.

### **ACTIVITY LAYOUT**

- Place two targets on the ground approximately 30 m (100 feet) apart.
- Mark a line on the ground from which the cadets will heave a line at the opposite target.

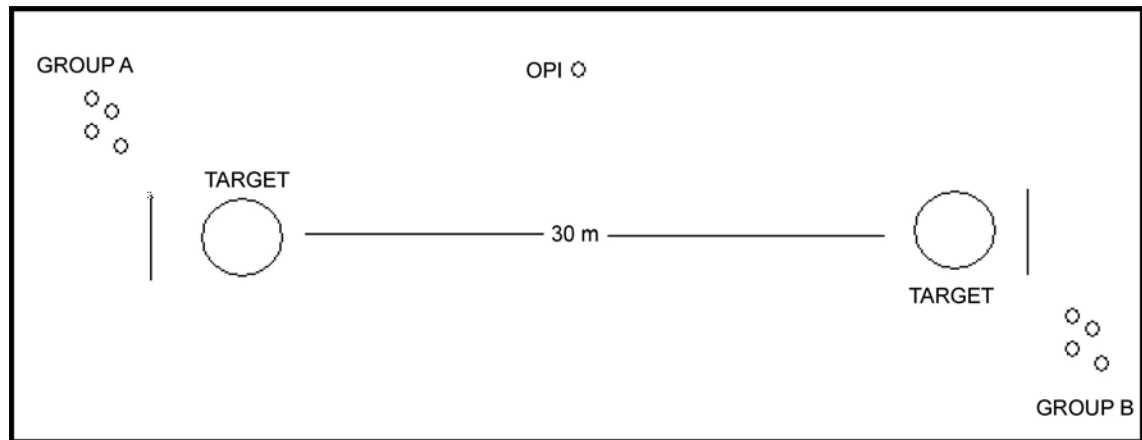

*Director Cadets 3, 2006, Ottawa, ON: Department of National Defence*

Figure 17-1 Coil and Heave a Line Activity Layout

### ACTIVITY INSTRUCTIONS

1. Divide each team (division) into two groups – Group A and Group B.
2. Assign each group a target station and a designated target.
3. Have one cadet from Group A step up to the line and throw a heaving line at the target. If the cadet is unsuccessful, they must retrieve the line and the next cadet from their group will attempt to hit the target.
4. Once Group A has hit the target, Group B must retrieve the line from their side and attempt to throw a heaving line at their assigned target.
5. The team (division) will be awarded one point for every successful target hit. Points will be accumulated until the time has expired or the activity is complete.



A homemade bollard can also be incorporated into this activity. In this situation, once the target has been successfully hit, the cadets would have to clear the heaving line to the bollard before a point is awarded to the group. By doing this the cadets will be experiencing a small component of securing a ship to a dock or jetty.

### SAFETY

Ensure that no cadets are near the targets when the heaving line is being tossed.

---

### ACTIVITY 2 – BOATSWAIN'S CALL

Time: 30 min

---

### OBJECTIVE

The objective of this activity is to have the cadets identify and sound different pipes.

### RESOURCES

- Boatswain's Call Cards located at Annex C,
- Container to hold Boatswain's Call Cards,

- Boatswain's call,
- Cleaning supplies,
- Whistle,
- Scoring sheet located at Annex A, and
- Pen/pencil.

### ACTIVITY LAYOUT

Place the boatswain's call and the Boatswain's Call Cards in a container and lay them near the OPI (as illustrated in Figure 16-2).

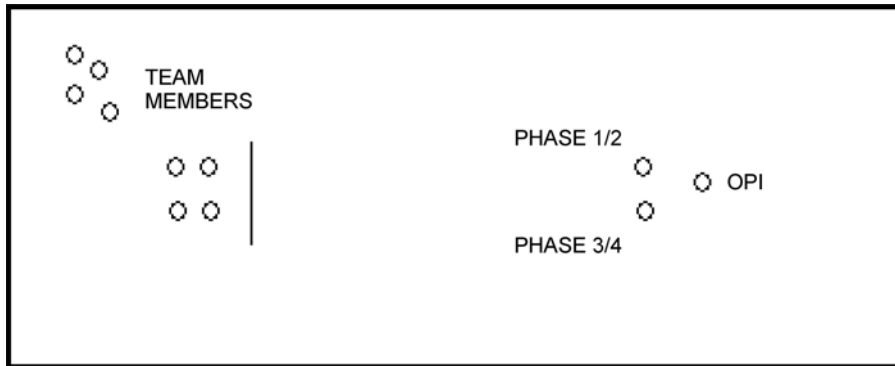

*Director Cadets 3, 2006, Ottawa, ON: Department of National Defence*

Figure 17-2 Boatswain's Call Activity Layout

### ACTIVITY INSTRUCTIONS

1. Divide the team (division) into two groups by phase. The first group will consist of Phase One and Phase Two cadets and the second group will consist of Phase Three and Phase Four cadets.
2. Have each Phase One cadet partner with a Phase Three cadet and each Phase Two cadet with a Phase Four cadet.
3. Have one set of partners approach the station OPI. Have the Phase Three or Phase Four cadet select a boatswain's call card from the container.
4. Have the remainder of the team members stand a distance away to avoid hearing the answers given (as illustrated in Figure 16-2).
5. Have the Phase Three or Phase Four cadet attempt to sound the pipe. They may be given three attempts to sound the pipe correctly. Once the pipe is sounded correctly, their partner is to attempt to identify the call, its use and where/when it is commonly used at the corps.
6. If the pipe is not sounded correctly after the three attempts, their partner may not identify the pipe and the partners will return to their team. No points will be awarded in this situation.
7. Each set of partners will follow Steps 3. to 5. until the time has lapsed.
8. Points are awarded as follows:
  - (a) five points for every pipe sounded correctly;
  - (b) one point (for a maximum of three) for every cadet who can correctly identify the pipe, explain its purpose and identify where/when used at the corps.



**SAFETY**

Ensure the boatswain's calls are cleaned between uses.

---

**ACTIVITY 3 – KNOTS, HITCHES AND BENDS**

---

Time: 30 min

---

**OBJECTIVE**

The objective of this activity is to have the cadets practice the knots, hitches and bends learned throughout the corps training.

**RESOURCES**

- Line (1 m [3.5 feet] long),
- Small spar/dowel,
- Six foot table,
- Container,
- Task cards located at Annex D,
- Whistle,
- Scoring sheet located at Annex A, and
- Pen/pencil.

**ACTIVITY LAYOUT**

- Place the station OPI's table approximately 10 m (33 feet) from the starting line (as illustrated in Figure 16-3).
- Place the container of task cards and the line on the table.

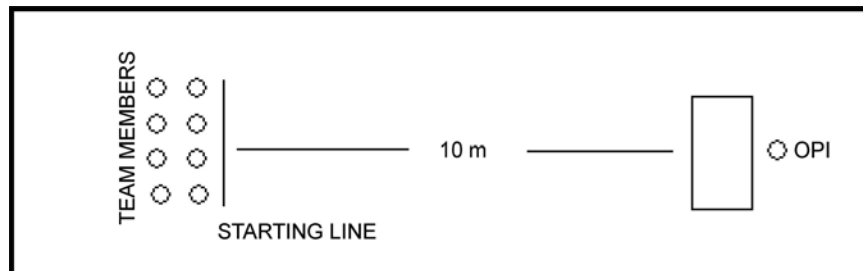

*Director Cadets 3, 2006, Ottawa, ON: Department of National Defence*

Figure 17-3 Knots, Bends and Hitches Activity Layout

**ACTIVITY INSTRUCTIONS**

1. One at a time, have each team member run to the station OPI's table and select a task card from the container.
2. Upon selecting a task card, have the cadet attempt to tie the selected knot with no assistance.



Complementary knots and hitches may be added to those listed at Annex D.

3. Upon successful completion, have the cadet return to the starting line, tag the next cadet who will run to the station OPI's table and complete Steps 1. to 3. accordingly.
4. Have each cadet complete Steps 1. to 3. until the time has lapsed.
5. Award points as they appear on the task cards for each successful task completed.

### **SAFETY**

Ensure there are no obstacles in the area the cadets will be running.

---

## **ACTIVITY 4 – WHIPPING AND SPLICING**

Time: 30 min

---

### **OBJECTIVE**

The objective of this activity is to practice whipping and splicing a line.

### **RESOURCES**

- Line (1 m [3.5 feet] per Phase One and Phase Two cadets),
- Three-strand line (1 m [3.5 feet] per Phase Three and Four cadets),
- Whipping twine (one spool),
- Cutting tool,
- Six foot table,
- Whistle,
- Scoring sheet located at Annex A, and
- Pen/pencil.

## ACTIVITY LAYOUT

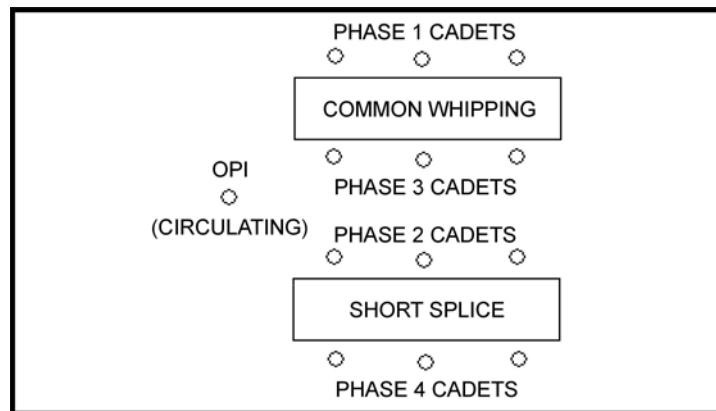

*Director Cadets 3, 2006, Ottawa, ON: Department of National Defence*

Figure 17-4 Whipping and Splicing Activity Layout

## ACTIVITY INSTRUCTIONS

1. Divide the cadets into groups by phase. The first group will consist of Phase One and Phase Three cadets and the second group will consist of Phase Two and Phase Four cadets.
2. Have each Phase One cadet, with the verbal assistance of a Phase Three cadet, whip the end of a line.



The cadets may use a common whipping for this activity. If the corps choose to instruct C121.01 (Whip the End of a Line Using a West Country Whipping, A-CR-CCP-601/PF-001, Chapter 10, Section 4) or C121.02 (Whip the End of a Line Using a Sailmaker's Whipping, A-CR-CCP-601/PF-001, Chapter 10, Section 5) they may choose to use one of these methods to whip the end of a line for this activity.

3. Have each Phase Two cadet, with the verbal assistance of a Phase Four cadet, complete a short splice.
4. Award points as follows:
  - (a) two points for each successful whipping;
  - (b) two points for each successful short splice; and
  - (c) five points for each Phase Three and Phase Four cadet who displays positive reinforcement, topic knowledge, proper direction and motivation throughout their assistance to the Phase One and Phase Two cadets.

## SAFETY

N/A.

---

## ACTIVITY 5 – TRIVIA

---

Time: 30 min

---

### OBJECTIVE

The objective of this activity is to reinforce theory knowledge and skills from the cadets' respective phase training through questions and tasks.

### RESOURCES

#### Option One

- Six foot table,
- Chairs,
- Whistle,
- List of Suggested Trivia Questions located at Annex B,
- Scoring sheet located at Annex A, and
- Pen/pencil.

#### Option Two

- Six foot table,
- Chairs,
- Buzzer,
- Question board,
- List of Suggested Trivia Questions located at Annex B,
- Whistle,
- Scoring sheet located at Annex A, and
- Pen/pencil.

### ACTIVITY LAYOUT

For Option One set up the activity as a stand-alone station that teams will rotate into the same as each other activity. Set up chairs for one team (division), as illustrated in Figure 16-5.

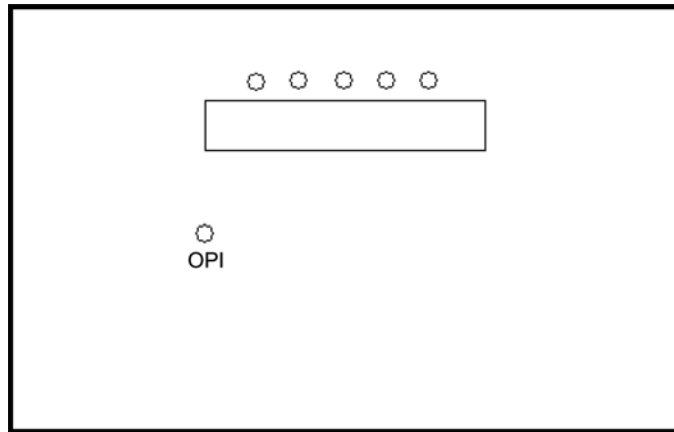

*Director Cadets 3, 2006, Ottawa, ON: Department of National Defence*

Figure 17-5 Option One Trivia Activity Layout

For Option Two set up the activity as a head-to-head competition between all of the teams (divisions), as illustrated in Figure 16-6.

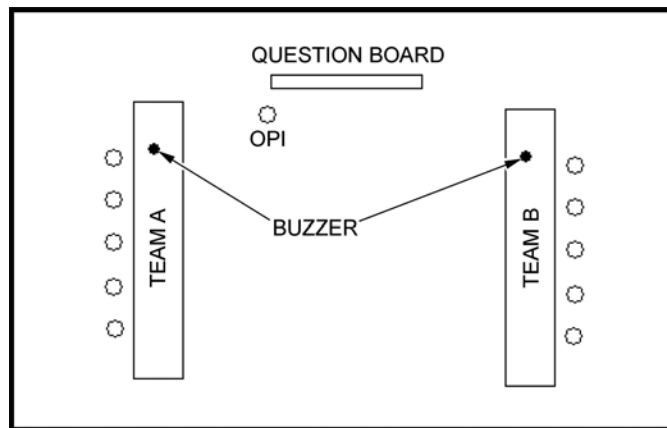

*Director Cadets 3, 2006, Ottawa, ON: Department of National Defence*

Figure 17-6 Option Two Trivia Activity Layout

## ACTIVITY INSTRUCTIONS



Cadets shall not be asked trivia questions from beyond their own year of phase training (e.g., Phase One cadets are only asked questions from Phase One but Phase Four cadets can be asked questions from Phase One, Two Three or Four).

### Option One

1. Ask each cadet questions from the list on the Suggested Trivia Questions located at Annex B.
2. Ask the questions to each cadet one at a time.
3. Give each team three lifelines to assist them in answering the questions:
  - (a) ask an officer;
  - (b) refer to their training materials; and

- (c) team vote.
- 4. Award points as follows:
  - (a) one point will be awarded for every correct response given with the use of a lifeline;
  - (b) two points will be awarded for every unassisted correct response; and
  - (c) five points will be awarded for every bonus question answered correctly.



Lifelines may not be used for bonus questions.

### Option Two

1. Hold a draw to determine where teams (divisions) will be placed in the round robin.
2. Have two teams play against each other to determine a winner.
3. Have the winning teams play off against each other to determine the final winner.
4. Give each team three lifelines to assist them in answering the questions:
  - (a) ask an officer;
  - (b) refer to their training materials; and
  - (c) team vote.
5. Pose a question and have the teams hit their buzzer to determine which team will get the chance to respond to the question.
6. Award points as follows:
  - (a) one point will be awarded for every correct response given with the use of a lifeline;
  - (b) two points will be awarded for every unassisted correct response; and
  - (c) five points will be awarded for every bonus question answered correctly

### SAFETY

N/A.

---

## ACTIVITY 6 – SHEER LEGS

Time: 60 min

---

### OBJECTIVE

The objective of this activity is to have the cadets erect a set of sheers.

### RESOURCES

#### General

- Hard hat (one per cadet),

- Two wooden spars each approximately 4.5 m (15 feet) long,
- Manila line 12 mm (0.5 inches) in diameter (9 m [30 feet] long),
- Five steel spikes with eyelets at the top (1 m [3.5 feet] long),
- Roll of whipping twine,
- Load of approximately 18 kg (40 pounds), and
- One steel spike with two eyelets (1 m [3.5 feet] long).

**Topping Lift**

- Two single blocks,
- Manila line 16 mm (0.6 inches) in diameter (68 m [223 feet] long), and
- Strop.

**Splay Tackle**

- One double block,
- One single block c/w becket,
- Manila Line 12 mm (0.5 inches) in diameter (17 m [56 feet] long).
- Two strops.

**Heel Tackles**

- Four double blocks,
- Four single blocks, and
- Four strops.

**Load Purchase**

- Two double blocks,
- One single block,
- Manila line 12 mm (0.5 inches) in diameter (approximately 30 m [100 feet] long), and
- Strop.

**ACTIVITY LAYOUT**

N/A.

**ACTIVITY INSTRUCTIONS**

1. Have each team erect a set of sheers. A set of instructions complete with illustrations may be available for the cadets.
2. Have the cadets complete the tasks associated with their respective phase training (e.g., Phase One cadets should complete the strops, Phase Two cadets should mouse the hooks, etc).
3. Points will be awarded IAW the Scoresheet located at Annex A.

## SAFETY

- Ensure all cadets wear personal safety equipment at all times throughout this activity.
- Ensure all cadets stay clear of the load as it is raised and lowered.

---

## ACTIVITY 7 – MODEL SHIP

Time: 240 min (completed throughout the two days and judged at the end of day 2)

---

## OBJECTIVE

The objective of this activity is to have the teams (divisions) each complete a model ship highlighting specific ship characteristics.

## RESOURCES

- Black bristol board (one sheet per team),
- Grey bristol board (one sheet per team),
- Scissors (one pair per team),
- Tape (one roll per team),
- Paper clips (one small box per team),
- Large tub of water (to test buoyancy),
- Pictures of ships located at Annex E,
- Scoresheet located at Annex A,
- Markers (one package per team), and
- Glue (one per team).



Other resources may be used, if desired, to add creativity to the model ships. Sample resources may include:

- pipe cleaners,
- popsicle sticks, and
- toothpicks, etc.

## ACTIVITY LAYOUT

N/A.

## ACTIVITY INSTRUCTIONS

- Provide the teams (divisions) with time throughout the two day activity to work on building a model ship.
- Have the teams build a three-dimensional model of a ship, using only the resources provided them.
- The model ship can be any size and type using the given resources.
- Each model ship must contain the following characteristics:



- bridge,
  - deck,
  - bow,
  - hull,
  - transom,
  - stern,
  - structure,
  - buoyancy, and
  - superstructure.
- Award points IAW the scoresheet located at Annex A, based on the following:
    - ship type accuracy,
    - use of resources,
    - hull structure,
    - hull design,
    - presentation,
    - buoyancy, and
    - overall appearance.



Teams may add other characteristics to their model ship if they wish. Some additional characteristics may include:

- anchor,
- rudder,
- propellers, and
- port holes, etc.

## SAFETY

N/A.

---

## ACTIVITY 8 – TEAM-BUILDING – (ONGOING THROUGHOUT THE TWO DAYS)

---

### ACTIVITY 8 (A) – MOST LIKE ME

Time: 10 min

---

## OBJECTIVE

The objective of this activity is to have the cadets participate in an icebreaker team-building activity for team members to get to know each other better.

## RESOURCES

- Most Like Me activity sheet (one per cadet) located at Annex F, and
- Pen/pencil (one per cadet).

## ACTIVITY LAYOUT

N/A.

## ACTIVITY INSTRUCTIONS

1. Distribute the Most Like Me activity sheet to each cadet.
2. Have the cadets look at the pictures on the activity sheet and place an 'X' in the corner of the pictures that are most like them.
3. Allow the cadets approximately five minutes to complete the activity sheet.
4. Have the cadets come together and share which pictures are most like them with the rest of the cadets.

## SAFETY

N/A.

---

## ACTIVITY 8 (B) – ACROSS THE RIVER

Time: 30 min

---

## OBJECTIVE

The objective of this activity is to provide the teams the opportunity to solve problems while participating in physical activities.

## RESOURCES

Two pieces of line (4 m [14 feet] long).

## ACTIVITY LAYOUT

Lay each piece of line across an open space approximately 20 m apart (as illustrated in Figure 16-7).

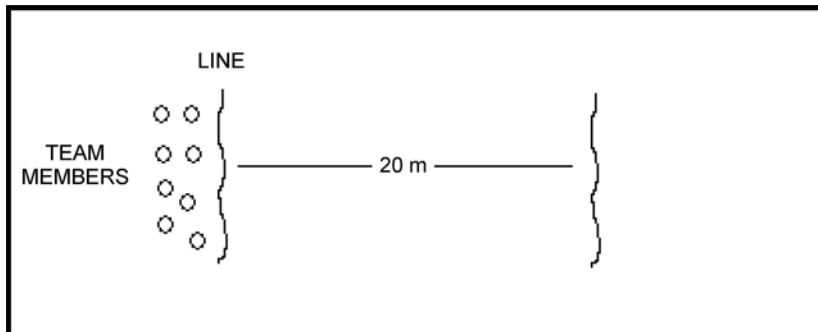

*Director Cadets 3, 2006, Ottawa, ON: Department of National Defence*

Figure 17-7 Across the River Activity Layout

**ACTIVITY INSTRUCTIONS**

1. Have the team (division) stand behind one of the lines. This will become the starting point.
2. Explain that the team is to go from one line to the other by only placing a designated number of feet on the ground at one given time (e.g., if there are 10 cadets, perhaps only 14 feet may be on the ground at a given time).
3. Explain that the team is to return by only placing a lesser number of designated feet on the ground at one time (e.g., the cadets then have to return by placing only 11 feet on the ground at a given time).

**SAFETY**

Ensure there are no hazards in the area where the activity will be conducted.

**ACTIVITY 8 (C) – SHERPA WALK**

Time: 30 min

**OBJECTIVE**

The objective of this activity is to have the team, while holding hands, walk through a path while blindfolded.

**RESOURCES**

Blindfold (one per cadet).

**ACTIVITY LAYOUT**

N/A.

**ACTIVITY INSTRUCTIONS**

1. Have two cadets volunteer to act as guides.
2. Take the two guides down the path to show them the way. These cadets will become the leaders and guide the remainder of the team through the path.
3. Inform the guides that they will not be permitted to touch or speak to the cadets. The guides are permitted to use sound signals (e.g., clap, whistle, snap, etc) as signals to the team.
4. Have the remainder of the cadets arrange themselves in a line and put on their blindfolds.
5. Have one guide at the front of the line and one guide at the rear.
6. Have the guides lead their team through the path using the sound signals.

**SAFETY**

- Teams must hold hands throughout the activity.
- Ensure the path is free of any major obstacles.

---

## ACTIVITY 9 – FINAL EVENT

---

Time: 90 min

---

### OBJECTIVE

The objective of this activity is to review all aspects of the seamanship competition.

### RESOURCES

- Whistle,
- Boatswain's call (one per division),
- Line (1 m [3.5 feet] per division),
- Task cards located at Annex D (one set per division),
- Heaving line (one per division),
- Single blocks (per division),
- Double blocks (per division),
- Manila line 12 mm (0.5 inches) in diameter (one 17 m [56 feet] length per division),
- Small box (one per division),
- Target (one per division), and
- Secret message cards located at Annex G (one set per division).

### ACTIVITY LAYOUT

- Set up the activity (as illustrated in Figure 16-8) if enough resources are available for each team (division) to compete at one time against each other.
- If enough resources are not available for each team (division) to compete at one time, one relay should be set up and each team (division) will compete and be timed.
- Set up four stations as follows:
  - Station 1 – Pipes;
  - Station 2 – Knots, Hitches and Bends;
  - Station 3 – Heaving Line; and
  - Station 4 – Luff Purchases.

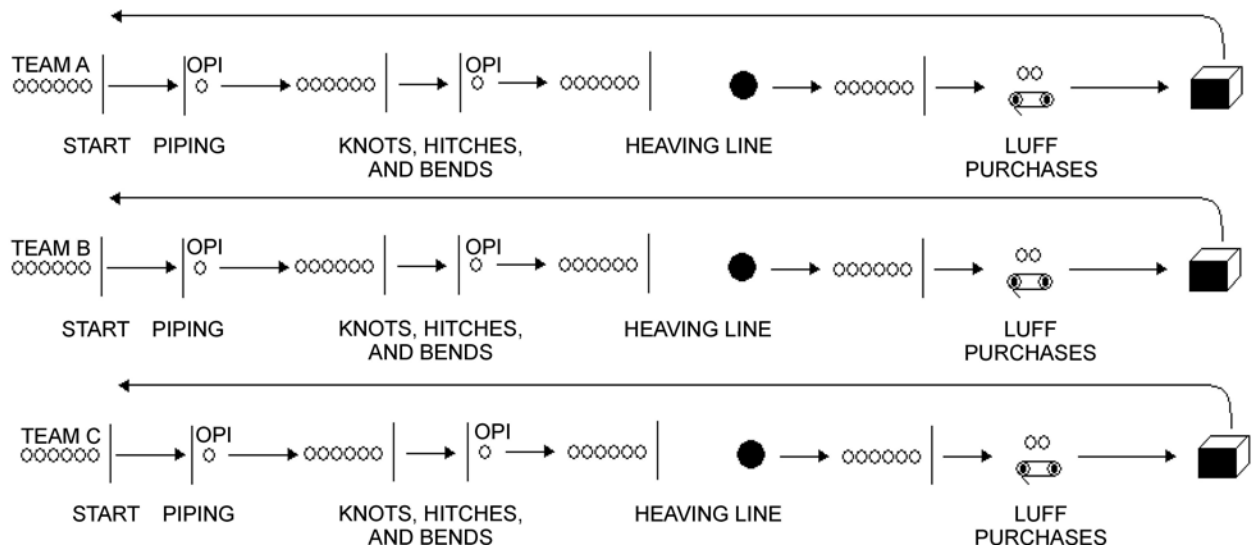

*Director Cadets 3, 2006, Ottawa, ON: Department of National Defence*

Figure 17-8 Final Event Layout

### ACTIVITY INSTRUCTIONS

1. Explain the following rules to the cadets:
  - (a) each team (division) is to lineup behind the starting point;
  - (b) each team is to travel as a group (e.g., no member can travel to the next station until the previous one has been completed, then the team shall travel together to the next station);
  - (c) on the start signal the teams will travel through each station in sequence (as illustrated in Figure 16-8); and
  - (d) upon completion of each station, the team will be given a secret message card which will be used to decipher a secret message upon completion of the activity.
2. Explain Station 1 to the cadets, to include:
  - (a) one cadet being given the name of a pipe and having to sound that pipe;
  - (b) if the cadet is able to correctly sound the pipe, the team will be given one secret message card and will advance as a team to the next station;
  - (c) if the cadet is unable to correctly sound the pipe, the next cadet should attempt to sound the pipe (this should continue through all of the cadets until the pipe is sounded successfully) and the team will advance to the next station; and
  - (d) if no cadets on the team are able to successfully sound the pipe, they must wait 15 seconds after the last team has moved to the next station before they may advance to the next station.
3. Explain Station 2 to the cadets, to include:
  - (a) one cadet from the team (division) at a time will approach the station OPI and select a task card;
  - (b) the cadet must explain the purpose of the knot, hitch or bend and tie the knot for the OPI;
  - (c) this process shall continue until three cadets have successfully completed this for the team; and

- (d) when the team is successful three times, they will be given a secret message card for each successful attempt (for a maximum of three) and advance as a team to the next station.
4. Explain Station 3 to the cadets, to include:
    - (a) one cadet at a time advancing to the starting point, retrieving the heaving line, coiling it and tossing it at the target;
    - (b) each successive cadet repeating the process of advancing to the starting point, retrieving the heaving line, coiling it and tossing it at the target until the target has been successfully hit three times; and
    - (c) when the team has been successful three times, they will be given a secret message card for each successful attempt (for a maximum of three) and advance as a team to the next station.
  5. Explain Station 4 to the cadets, to include:
    - (a) selecting two members of the team (division) to attempt to properly reeve the lines of a luff;
    - (b) if the initial members are unsuccessful, they must return and two new members will attempt to properly reeve the purchase;
    - (c) this will continue until the team is successful;
    - (d) when the team is successful, they will be given two secret message cards and advance as a team to the finishing point;
    - (e) upon arriving at the finishing point, the cadets must attempt to decipher the secret message.
  6. Have the cadets participate in the activity.
  7. Points will be awarded IAW the Scoresheet located at Annex A.

**SAFETY**

Ensure the area is clear from any major obstacles.

---

**END OF LESSON CONFIRMATION**

---

The cadets' participation in the Seamanship Interdivisional Competition will serve as the confirmation of this lesson.

---

**CONCLUSION**

---

**HOMEWORK/READING/PRACTICE**

N/A.

**METHOD OF EVALUATION**

N/A.

**CLOSING STATEMENT**

It is important to participate in this competition as it will reinforce many areas of skills and knowledge learned throughout the corps training. It will allow an opportunity for the instructors to evaluate your knowledge and skills. It will provide a further opportunity for team-building for all members of the corps as it reinforces the

divisional system and ensures all divisions and corps members work together and interact to meet a common goal.

**INSTRUCTOR NOTES/REMARKS**

N/A.

---

**REFERENCES**

---

- C1-002 (ISBN 0-7858-1446-9) Pawson, D. (2001). *Pocket Guide to Knots and Splices*. Edison, NJ: Charwell Books, Inc.
- C1-003 (ISBN 11-770973-5) Royal Navy. (1972). *Admiralty Manual of Seamanship 1964* (Vol.1). London, England: Her Majesty's Stationery Office.
- C1-005 (ISBN 0-07-134984-7) West, E. (1999). *The Big Book of Icebreakers: Quick, Fun Activities for Energizing Meetings and Workshops*. New York, NY: McGraw-Hill, Inc.
- C1-006 (ISBN 0-8403-5682-X) Rohnke, K. (1984). *Silver Bullets: A Guide to Initiative Problems, Adventure Games and Trust Activities*. Iowa: Kendall/Hunt Publishing Company.

THIS PAGE INTENTIONALLY LEFT BLANK



**SCORESHEETS**

---

**COIL AND HEAVE A LINE**

---

**TEAM NAME:**

**AWARDING POINTS**

Teams will be awarded one point for every successful line tossed into the designated target.

Points Awarded
Overall Total:

**OPI Name:**

**Date:**

**BOATSWAIN CALL**

**TEAM NAME:**

**AWARDING POINTS**

Teams will be awarded five points for every correctly sounded pipe. For identifying the pipe, explaining the pipes purpose and identifying common areas the pipe is used at the corps, the team will be awarded one point for each.

Points Awarded		
Pipe Sounded Correctly	Correct - 5 pts	Incorrect - 0 pt
Pipe Identified Correctly	Correct - 1 pt	Incorrect - 0 pt
Purpose Explained	Correct - 1 pt	Incorrect - 0 pt
Common Areas Identified	Correct - 1 pt	Incorrect - 0 pt
		Subtotal:
Pipe Sounded Correctly	Correct - 5 pts	Incorrect - 0 pt
Pipe Identified Correctly	Correct - 1 pt	Incorrect - 0 pt
Purpose Explained	Correct - 1 pt	Incorrect - 0 pt
Common Areas Identified	Correct - 1 pt	Incorrect - 0 pt
		Subtotal:
Pipe Sounded Correctly	Correct - 5 pts	Incorrect - 0 pt
Pipe Identified Correctly	Correct - 1 pt	Incorrect - 0 pt
Purpose Explained	Correct - 1 pt	Incorrect - 0 pt
Common Areas Identified	Correct - 1 pt	Incorrect - 0 pt
		Subtotal:
Pipe Sounded Correctly	Correct - 5 pts	Incorrect - 0 pt
Pipe Identified Correctly	Correct - 1 pt	Incorrect - 0 pt
Purpose Explained	Correct - 1 pt	Incorrect - 0 pt
Common Areas Identified	Correct - 1 pt	Incorrect - 0 pt
		Subtotal:
Pipe Sounded Correctly	Correct - 5 pts	Incorrect - 0 pt
Pipe Identified Correctly	Correct - 1 pt	Incorrect - 0 pt
Purpose Explained	Correct - 1 pt	Incorrect - 0 pt
Common Areas Identified	Correct - 1 pt	Incorrect - 0 pt
		Subtotal:
<b>Overall Total:</b>		

**OPI Name:**

**Date:**

**KNOTS, HITCHES AND BENDS**

**TEAM NAME:**

**AWARDING POINTS**

Teams will be awarded points for every task completed correctly. Point value will be IAW the points indicated on the task cards.

<b>Points Awarded</b>					
<b>Tie Knots</b>					
5 pts	5 pts	5 pts	5 pts	5 pts	5 pts
5 pts	5 pts	5 pts	5 pts	5 pts	5 pts
					Subtotal:
<b>Who Am I?</b>					
3 pts	3 pts	3 pts	3 pts	3 pts	3 pts
3 pts	3 pts	3 pts	3 pts	3 pts	3 pts
					Subtotal:
<b>Definition</b>					
2 pts	2 pts	2 pts	2 pts	2 pts	2 pts
2 pts	2 pts	2 pts	2 pts	2 pts	2 pts
					Subtotal:
<b>Visual Identification</b>					
1 pt	1 pt	1 pt	1 pt	1 pt	1 pt
1 pt	1 pt	1 pt	1 pt	1 pt	1 pt
					Subtotal:
					<b>Overall Total:</b>

**OPI Name:**

**Date:**

---

**WHIPPING AND SPLICING**

---

**TEAM NAME:**

**AWARDING POINTS**

Teams will be awarded two points for every correct short splice and whipping. The OPI will also assess the phase three and four cadets' ability to provide guidance and assistance. The OPI will look for things such as positive reinforcement, topic knowledge, proper direction and motivation.

<b>Points Awarded</b>					
<b>Whippings Completed</b>					
2 pts	2 pts	2 pts	2 pts	2 pts	2 pts
2 pts	2 pts	2 pts	2 pts	2 pts	2 pts
					Subtotal:
<b>Splices Completed</b>					
2 pts	2 pts	2 pts	2 pts	2 pts	2 pts
2 pts	2 pts	2 pts	2 pts	2 pts	2 pts
					Subtotal:
<b>Leadership</b>					
	1 pt	2 pts	3 pts	4 pts	5 pts
	6 pts	7 pts	8 pts	9 pts	10 pts
					Subtotal:
					<b>Overall Total:</b>

**OPI Name:**

**Date:**

**TRIVIA (OPTION ONE)**

**TEAM NAME:**

**AWARDING POINTS**

Teams will be awarded two points for every correct short splice and whipping. The OPI will also assess the phase three and four cadets' ability to provide guidance and assistance. The OPI will look for things such as positive reinforcement, topic knowledge, proper direction and motivation.

<b>Points Awarded</b>		
Question # 1	Correct 2 pts	Incorrect 0
Question # 2	Correct 2 pts	Incorrect 0
Question # 3	Correct 2 pts	Incorrect 0
Question # 4	Correct 2 pts	Incorrect 0
Question # 5	Correct 2 pts	Incorrect 0
Question # 6	Correct 2 pts	Incorrect 0
Question # 7	Correct 2 pts	Incorrect 0
Question # 8	Correct 2 pts	Incorrect 0
Question # 9	Correct 2 pts	Incorrect 0
Question # 10	Correct 2 pts	Incorrect 0
Question # 11	Correct 2 pts	Incorrect 0
Question # 12	Correct 2 pts	Incorrect 0
Question # 13	Correct 2 pts	Incorrect 0
Question # 14	Correct 2 pts	Incorrect 0
Question # 15	Correct 2 pts	Incorrect 0
Bonus Question:	Correct 5 pts	Incorrect 0
<b>LIFELINES:</b>		
Ask an officer:	- 1 pt	
Reference manuals:	- 1 pt	
Team vote:	- 1 pt	
<b>Overall Total:</b>		

**OPI Name:**

**Date:**

---

**TRIVIA (OPTION TWO)**

---

**TEAM NAME:**

**AWARDING POINTS**

Teams will be awarded one point for every correct response given with the use of a lifeline, two points for every unassisted correct response and five points for every bonus question answered correctly.

<b>Points Awarded</b>		
Question # 1	Point Value Awarded:	_____
Question # 2	Point Value Awarded:	_____
Question # 3	Point Value Awarded:	_____
Question # 4	Point Value Awarded:	_____
Question # 5	Point Value Awarded:	_____
Question # 6	Point Value Awarded:	_____
Question # 7	Point Value Awarded:	_____
Question # 8	Point Value Awarded:	_____
Question # 9	Point Value Awarded:	_____
Question # 10	Point Value Awarded:	_____
Question # 11	Point Value Awarded:	_____
Question # 12	Point Value Awarded:	_____
Question # 13	Point Value Awarded:	_____
Question # 14	Point Value Awarded:	_____
Question # 15	Point Value Awarded:	_____
		<b>Overall Total:</b>

**OPI Name:**

**Date:**

**SHEERS**

**TEAM NAME:**

**AWARDING POINTS**

Teams will be awarded points IAW the scoring guide.

Points Awarded						
<b>HEAD LASHING—proper, tight, neat and secure.</b>						
Clove Hitch	3 pts	2 pts	1 pt			
Correct Number of Turns	1 pt					
Tight and Secure	2 pts	1 pt				
						Subtotal:
<b>TOPPING LIFT—Double Whip</b>						
Lines Rove	3 pts	2 pts	1 pt			
Hooks Moused	3 pts	2 pts	1 pt			
Strops	1 pt					
						Subtotal:
<b>SPLAY TACKLE—Luff</b>						
Lines Rove	3 pts	2 pts	1 pt			
Hooks Moused	3 pts	2 pts	1 pt			
Strops	1 pt					
						Subtotal:
<b>HEEL TACKLES—Luff (four)</b>						
Lines Rove	5 pts	4 pts	3 pts	2 pts	1 pt	
Hooks Moused	5 pts	4 pts	3 pts	2 pts	1 pt	
Strops	3 pts	2 pts	1 pt			
						Subtotal:
<b>LOAD PURCHASE—Double Block</b>						
Lines Rove	5 pts	4 pts	3 pts	2 pts	1 pt	
Hooks Moused	5 pts	4 pts	3 pts	2 pts	1 pt	
Strops	3 pts	2 pts	1 pt			
						Subtotal:
<b>OVERALL APPEARANCE</b>						
	5 pts	4 pts	3 pts	2 pts	1 pt	
						Subtotal:
						<b>Overall Total:</b>

**OPI Name:**

**Date:**

---

**MODEL SHIP**

---

**TEAM NAME:**

**AWARDING POINTS**

Teams will be awarded points IAW the scoring guide.

<b>Points Awarded</b>				
<b>SHIP TYPE ACCURACY – the ship’s model is similar to that of the type chosen by the team.</b>				
1 pt	2 pts	3 pts	4 pts	5 pts
<b>USE OF RESOURCES – the team maximized the use of resources provided.</b>				
1 pt	2 pts	3 pts	4 pts	5 pts
<b>HULL STRUCTURE – the hull structure highlights the areas of the hull, bow, stern and transom.</b>				
1 pt	2 pts	3 pts	4 pts	5 pts
<b>HULL DESIGN – the hull design highlights the areas of the bridge, deck and superstructure.</b>				
1 pt	2 pts	3 pts	4 pts	5 pts
<b>PRESENTATION – the team presentation was clear, confident and involved maximum group participation.</b>				
1 pt	2 pts	3 pts	4 pts	5 pts
<b>BUOYANCY – the model floats even and steady.</b>				
1 pt	2 pts	3 pts	4 pts	5 pts
<b>OVERALL APPEARANCE – the model has many details.</b>				
1 pt	2 pts	3 pts	4 pts	5 pts
<b>Overall Total:</b>				

**OPI Name:**

**Date:**



---

**FINAL EVENT**

---

**AWARDING POINTS**

Teams will be awarded points IAW their finishing position.

<b>Points Awarded</b>	
<b>FIRST PLACE TEAM NAME:</b>	Points 50
<b>SECOND PLACE TEAM NAME:</b>	Points 40
<b>THIRD PLACE TEAM NAME:</b>	Points 30
<b>FOURTH PLACE TEAM NAME:</b>	Points 20
<b>FIFTH PLACE TEAM NAME:</b>	Points 10
<b>Overall Total:</b>	

**OPI Name:**

**Date:**

THIS PAGE INTENTIONALLY LEFT BLANK

## SUGGESTED TRIVIA QUESTIONS

### PHASE ONE

Q1. What is the purpose of one of the following knots hitches or bends:

- Reef Knot,
- Figure Eight Knot,
- Sheet Bend,
- Bowline,
- Clove Hitch, or
- Round Turn Two Half Hitches.

A1. The following answers apply:

- Reef Knot: to tie together two ropes of equal diameter.
- Figure Eight Knot: stopper knot.
- Sheet Bend: to tie together two ropes of unequal diameter.
- Bowline: to create a temporary eye in the end of a line.
- Clove Hitch: to secure a line to a spar.
- Round Turn Two Half Hitches: to secure a line to a ring or eye.
- Common Whipping: to finish the end of a line to prevent it from fraying or unravelling.

Q2. Define one of the following naval terms:

- Gash can,
- Stand easy,
- Secure,
- Heads,
- Duty watch,
- Out pipes,
- Scran locker,
- Pipe,
- Colours,
- Liberty boat,
- Bulkhead,
- Deck,
- Ship's company,
- Sunset,
- Gangway,
- Galley,
- Boatswain's stores,
- Pipe down,
- Kye,
- Aye Aye, Sir/Ma'am,
- Port,
- Starboard,
- Ship's Office,
- Gangway, and
- Brow.

A2. Answers:

- Gash can: garbage can.
- Stand easy: a break.
- Secure: to close up and put away gear.
- Heads: toilet(s).
- Duty watch: a division that is selected on a rotational basis that is responsible for corps preparation and cleanup.
- Out pipes: a pipe indicating the commencement of classes or the end of stand easy.
- Scran locker: lost and found.
- Pipe: sound produced from a boatswain's call. The notes played have a specific meaning/message.
- Colours: the ceremony of hoisting the national flag, usually in the morning or at the beginning of the training day.
- Liberty boat: when all personnel are dismissed for the day and may go ashore;
- Bulkhead: a wall.
- Deck: a floor.
- Ship's company: the complement of a ship (this would include a sea cadet corps).
- Sunset: the ceremony of lowering the national flag at the end of a training day.
- Gangway: any recognized entrance to, passageway or traffic route within a ship.
- Galley: the ship's kitchen.
- Boatswain's stores: a storeroom for cleaning gear.
- Pipe down: an order meaning to keep quiet.
- Kye: a hot chocolate drink.
- Aye Aye, Sir/Ma'am: order understood that will be obeyed, an appropriate response to an order from an officer.
- Port: left side of a ship.
- Starboard: right side of a ship.
- Ship's Office: administration office.
- Brow: entrance/exit of a ship where personnel must salute when coming aboard or going ashore.

Q3. What pipe is used to gain the attention of a ship's company before passing an order?

A3. General Call.

Q4. What pipe is used to bring the ship's company to attention?

A4. The Still.

Q5. What pipe is sounded after the reason for the still is complete?

A5. Carry On.

Q6. How many times do you ring a ship's bell for Colours/Sunset?

A6. The bell is rung as follows:

- Colours: eight times, and
- Sunset: four times.

## PHASE TWO

Q1. What are the three steps involved in bringing a naval vessel into service?

A1. The three steps involved in bringing a naval vessel into service are:

- keel laying;
- naming and launching; and
- commissioning.

Q2. What is the draught of a ship?

A2. The depth of the keel below the waterline at any point along the hull.

Q3. Identify the following splice (present the cadets with a pre-tied short splice).

A3. Short Splice.

Q4. What type of blocks does a luff consist of?

A4. One double block and one single block.

Q5. What tackle consists of two double blocks?

A5. Two-fold purchase.

Q6. What should you do to prevent a load from falling off a hook?

A6. Mouse the hook.

Q7. What part of the sailboat is used to hoist the sails?

A7. Halyards.

Q8. What helps prevent a sailboat from capsizing?

A8. Centreboard/Daggerboard.

Q9. What are sheets used for?

A9. To control the mainsail and jib sail.

Q10. What are some ways to determine wind direction?

A10. Flags, tall grass, smoke, small waves, wind sock, moored boats and low altitude clouds.

Q11. What times are associated with the first dog watch?

A11. 1600–1800 hours.

Q12. What times are associated with the forenoon watch?

A12. 0800-1200 hours.

Q13. What is the purpose of the dog watches?

A13. The dog watches are only half the time of the others to create a seventh watch, ensuring that personnel do not stand the same watch every day.

### PHASE THREE

- Q1. What ship is currently operating in \_\_\_\_\_ (the OPI should select a current deployment)?
- A1. Depends on current deployments.
- Q2. What are three safety precautions to consider when using lifting devices?
- A2. Wear a helmet, do not enter the safety zone and do not walk under the load.
- Q3. What is the purpose of a splay tackle?
- A3. To prevent the legs of a sheer from separating.
- Q4. How many turns should a head lashing consist of?
- A4. Eleven to fifteen.
- Q5. What part attaches to the load on sheers?
- A5. Main purchases.
- Q6. The bottom of a sail is known as what?
- A6. Foot.
- Q7. What part of the sailboat houses the centreboard?
- A7. Centreboard trunk.
- Q8. What should the crew of a sailboat do to help prevent heeling?
- A8. Hike.
- Q9. What does PFD stand for?
- A9. Personal floatation device.

**PHASE FOUR, FIVE AND SIX**

- Q1. Name one civilian maritime organization.
- A1. Department of Fisheries and Oceans, Canadian Coast Guard, etc.
- Q2. What is turning a sailboat so its bow passes through head to wind known as?
- A2. Tacking.
- Q3. The side the boat that the wind passes over first is known as what?
- A3. Windward side.



BOATSWAIN'S CALL CARDS

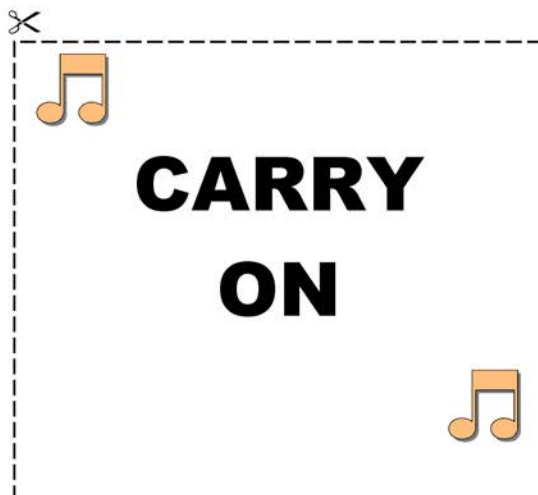
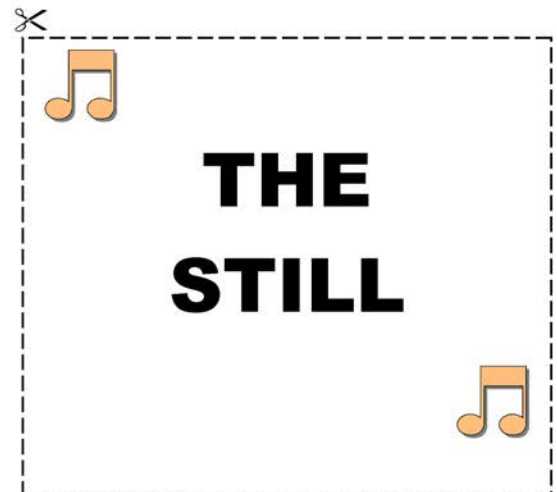
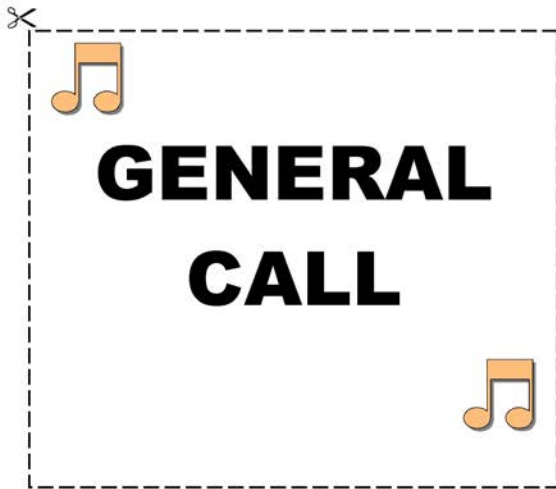

THIS PAGE INTENTIONALLY LEFT BLANK

TASK CARDS

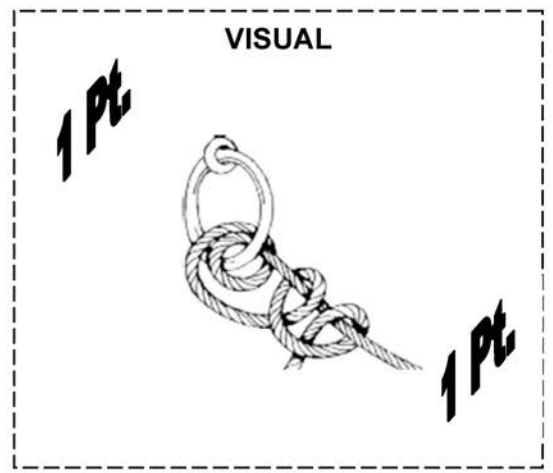
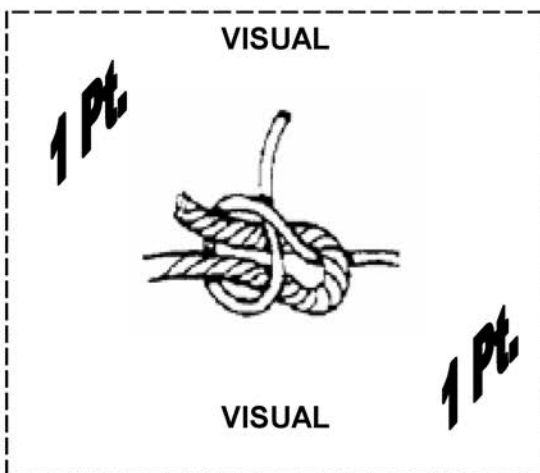
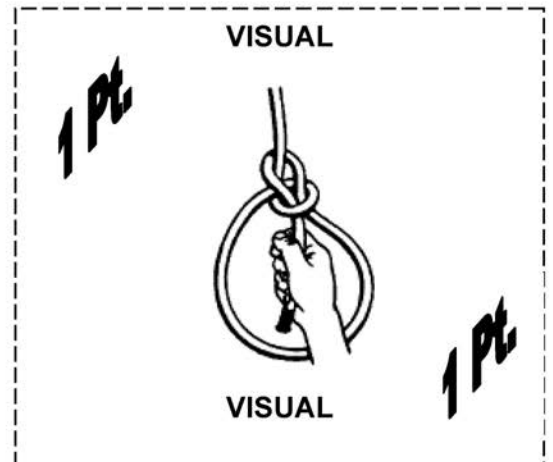
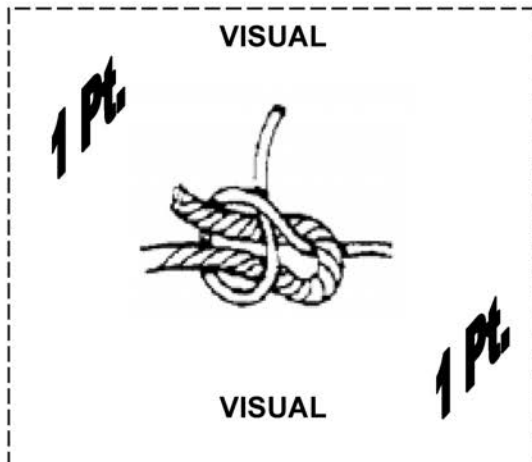
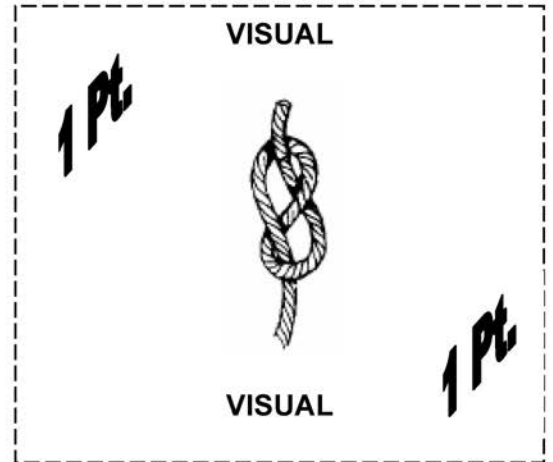
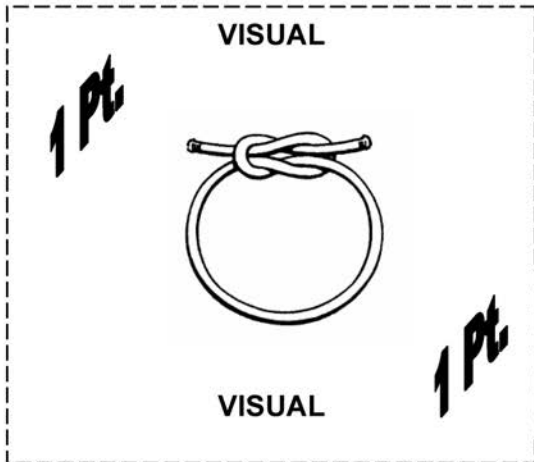



TIE KNOTS

**BOWLINE**

TIE KNOTS

5 PTS.

5 PTS.

TIE KNOTS

**FIGURE 8**

TIE KNOTS

5 PTS.

5 PTS.

TIE KNOTS

**SHEET BEND**

TIE KNOTS

5 PTS.

5 PTS.

TIE KNOTS

**REEF KNOT**

TIE KNOTS

5 PTS.

5 PTS.

TIE KNOTS

**CLOVE HITCH**

TIE KNOTS

5 PTS.

5 PTS.

TIE KNOTS

**ROUND TURN  
2 HALF HITCHES**

TIE KNOTS

5 PTS.

5 PTS.



WHO AM I?  
**3 PTS.**  
Stop the line from  
running all the  
way out the  
fairleads  
WHO AM I? **3 PTS.**

WHO AM I?  
**3 PTS.**  
Start tying me by  
making a six  
somewhere in  
the line  
WHO AM I? **3 PTS.**

WHO AM I?  
**3 PTS.**  
You can use me to  
temporarily tie  
up a small boat  
WHO AM I? **3 PTS.**

WHO AM I?  
**3 PTS.**  
Lines different  
diameters?  
I think I can  
help.  
WHO AM I? **3 PTS.**

WHO AM I?  
**3 PTS.**  
I am often used as  
the start when  
tying your  
shoes  
WHO AM I? **3 PTS.**

WHO AM I?  
**3 PTS.**  
My hitches should  
always be made with  
the running end going  
in the same direction.  
WHO AM I? **3 PTS.**



DEFINITION

**2 PTS.**

**REEF KNOT**

DEFINITION **2 PTS.**

DEFINITION

**2 PTS.**

**SHEET BEND**

DEFINITION **2 PTS.**

DEFINITION

**2 PTS.**

**BOWLINE**

DEFINITION **2 PTS.**

DEFINITION

**2 PTS.**

**FIGURE 8**

DEFINITION **2 PTS.**

DEFINITION

**2 PTS.**

**CLOVE HITCH**

DEFINITION **2 PTS.**

DEFINITION

**2 PTS.**

**ROUND TURN  
2 HALF HITCHES**

DEFINITION **2 PTS.**

## TYPES OF SHIPS



*Department of National Defence. Retrieved March 11, 2006, from [http://www.navy.forces.gc.ca/cms\\_images/ship\\_site\\_images/ship\\_gallery/283/ETD02-0081-30\\_l.jpg](http://www.navy.forces.gc.ca/cms_images/ship_site_images/ship_gallery/283/ETD02-0081-30_l.jpg)*

Figure 17E-1 HMCS Algonquin



*Department of National Defence. Retrieved on March 11, 2006, from [http://www.navy.forces.gc.ca/cms\\_images/ship\\_site\\_images/ship\\_gallery/710/cx2003-0152-22c.jpg](http://www.navy.forces.gc.ca/cms_images/ship_site_images/ship_gallery/710/cx2003-0152-22c.jpg)*

Figure 17E-2 HMCS Brandon





Department of National Defence. Retrieved on March 11, 2006, from [http://www.navy.forces.gc.ca/cms\\_images/ship\\_site\\_images/ship\\_gallery/334/Sailpast.jpg](http://www.navy.forces.gc.ca/cms_images/ship_site_images/ship_gallery/334/Sailpast.jpg)

Figure 17E-3 HMCS Regina



Department of National Defence. Retrieved on March 11, 2006, from [http://www.navy.forces.gc.ca/cms\\_images/ship\\_site\\_images/ship\\_gallery/509/prot11.jpg](http://www.navy.forces.gc.ca/cms_images/ship_site_images/ship_gallery/509/prot11.jpg)

Figure 17E-4 HMCS Protecteur





JCOMMOPS, 2001-2008. Retrieved on March 11, 2006, from [http://www.jcommops.org/graph\\_ref/cargo\\_ship-3.jpg](http://www.jcommops.org/graph_ref/cargo_ship-3.jpg)

Figure 17E-5 Cargo Vessel



CBS News. Retrieved on March 11, 2006, from <http://www.cbsnews.com/images/2006/03/24/imageSJU10103232114.jpg>

Figure 17E-6 Cruise Ship



Newfoundland Photo Gallery. Retrieved on March 11, 2006, from <http://www.geocities.com/Heartland/Pointe/5181/nfld/smallwood.jpg>

Figure 17E-7 Car Ferry



CMT Consulting Management Technology. Retrieved on March 11, 2006, from <http://www.cmt-gmbh.de/tanker%20ship.jpg>

Figure 17E-8 Tanker



Retrieved on March 11, 2006, from <http://ei4hq.shacknet.nu/corkHarbour/tugs/original/Gerry%20O'Sullivan%201.jpg>

Figure 17E-9 Tug Handling Supply Vessel

THIS PAGE INTENTIONALLY LEFT BLANK



MOST LIKE ME ACTIVITY SHEET



THIS PAGE INTENTIONALLY LEFT BLANK

SECRET MESSAGE CARDS

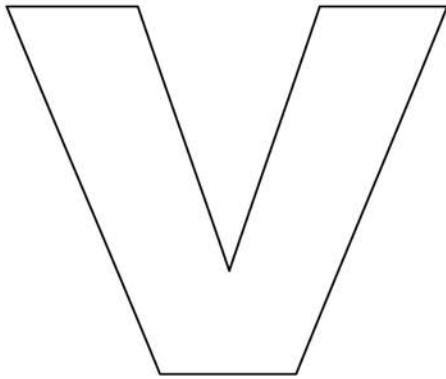
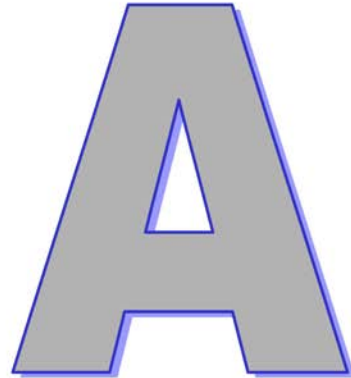

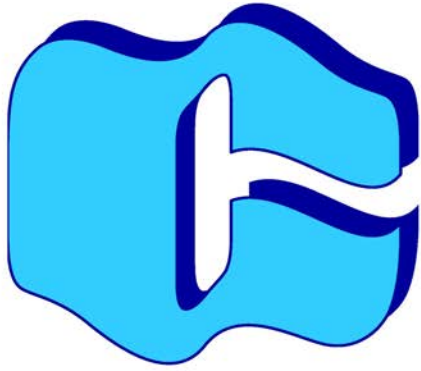

**Secret Message—"NAVY ROCKS"**